

TITAN[®]

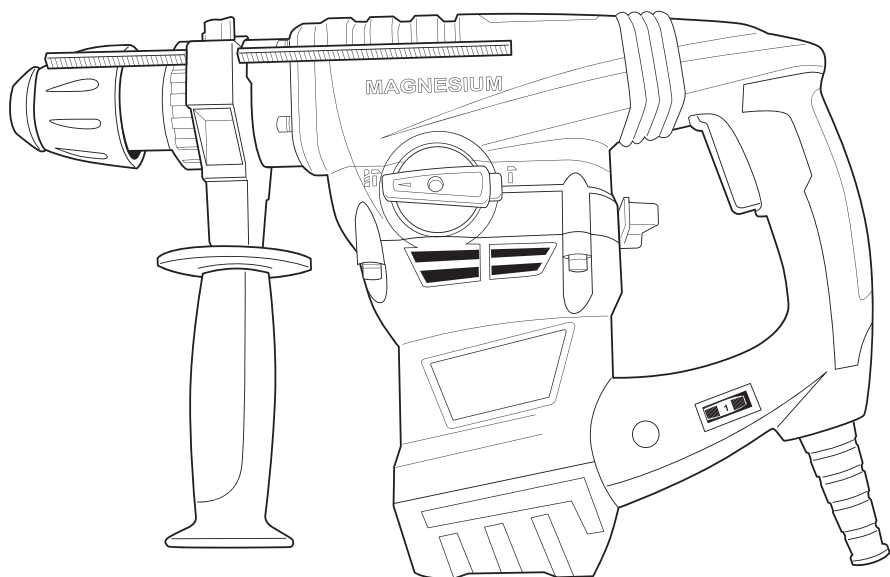

24 **month**
Manufacturer's
Warranty

SAFETY AND OPERATING MANUAL

Original instructions

ROTARY HAMMER 1500W TTB278SDS TTB279SDS

TITAN®

Congratulations on your purchase of a TITAN. power tool from Titan Power Tools (UK) Ltd. We want you to continue getting the best performance from it so this handbook includes information on safety, handling and care. Please retain this handbook in case you need to refer to any of the information in the future.

Your TITAN. power tool comes with a 24-month guarantee, so should it develop a fault within this period contact your retailer.

GUARANTEE

This **TITAN.** product carries a guarantee of 24 months. If your product develops a fault within this period, you should, in the first instance contact the retailer where the item was purchased.

This guarantee specifically excludes losses caused due to:

- Fair wear and tear
- Misuse or abuse
- Lack of routine maintenance
- Failure of consumable items (such as batteries)
- Accidental damage
- Cosmetic damage
- Failure to follow manufacturer's guidelines
- Loss of use of the goods

This guarantee does not affect your statutory rights. This guarantee is only valid in the UK.

For any enquiries relating to the guarantee please refer to your retailer.

CAUTION

This is a very powerful Drill.

When using this drill it is essential that the following rules for use are followed.

- 1.** When drilling it is common that the core / drill bit jams in the material being drilled. This will result in the drill trying to rotate around the drill bit and potentially come out of your grip. This SDS Drill has a safety clutch mechanism. This safety clutch mechanism will be activated and stop the drive to the drill bit BUT only if you resist the initial forces caused by the jamming by securely holding the drill with both hands. As this is a very powerful drill these forces are significant.
- 2.** ALWAYS ensure that the front handle is firmly affixed and secure.
- 3.** The Front and rear handle must be firmly held to resist any movement of the drill when the core drill or drill bit becomes jammed.
- 4.** ALWAYS use this drill when standing on a firm and secure platform or the ground.
(DO NOT USE ON LADDERS OR STEPS)
- 5.** NEVER Start the Drill with the core or drill jammed in position.
- 6.** DO NOT stretch to hold the drill. Do not drill above shoulder height or below Knee height, as the drill cannot be securely held.

GENERAL SAFETY INSTRUCTIONS



WARNING! Read all safety warnings designated by the symbol  and all instructions.



WARNING! Read all safety warnings and all instructions. Failure to follow the warnings and instructions may result in electric shock, fire and/or serious injury.
Save all warnings and instructions for future reference.

The term "power tool" in the warnings refers to your mains-operated (corded) power tool or battery-operated (cordless) power tool.

1. Work area safety

- a. Keep work area clean and well lit.** Cluttered or dark areas invite accidents.
- b. Do not operate power tools in explosive atmospheres, such as in the presence of flammable liquids, gases or dust.** Power tools create sparks which may ignite the dust or fumes.
- c. Keep children and bystanders away while operating a power tool.** Distractions can cause you to lose control.

2. Electrical safety

- a. Power tool plugs must match the outlet. Never modify the plug in any way. Do not use any adapter plugs with earthed (grounded) power tools.** Unmodified plugs and matching outlets will reduce risk of electric shock.
- b. Avoid body contact with earthed or grounded surfaces, such as pipes, radiators, ranges and refrigerators.** There is an increased risk of electric shock if your body is earthed or grounded.
- c. Do not expose power tools to rain or wet conditions.** Water entering a power tool will increase the risk of electric shock.
- d. Do not abuse the cord. Never use the cord for carrying, pulling or unplugging the power tool. Keep cord away from heat, oil, sharp edges or moving parts.** Damaged or entangled cords increase the risk of electric shock.
- e. When operating a power tool outdoors, use an extension cord suitable for outdoor use.** Use of a cord suitable for outdoor use reduces the risk of electric shock.
- f. If operating a power tool in a damp location is unavoidable, use a residual current device (RCD) protected supply.** Use of an RCD reduces the risk of electric shock.

3. Personal safety

- a. Stay alert, watch what you are doing and use common sense when operating a power tool. Do not use a power tool while you are tired or under the influence of drugs, alcohol or medication.** A moment of inattention while operating power tools may result in serious personal injury.
- b. Use personal protective equipment. Always wear eye protection.** Protective equipment such as dust mask, non-skid safety shoes, hard hat, or hearing protection used for appropriate conditions will reduce personal injuries.
- c. Prevent unintentional starting. Ensure the switch is in the off-position before connecting to power source and/or battery pack, picking up or carrying the tool.** Carrying power tools with your finger on the switch or energising power tools that have the switch on invites accidents.

d. Remove any adjusting key or wrench before turning the power tool on. A wrench or a key left attached to a rotating part of the power tool may result in personal injury.

e. Do not overreach. Keep proper footing and balance at all times. This enables better control of the power tool in unexpected situations.

f. Dress properly. Do not wear loose clothing or jewellery. Keep your hair, clothing and gloves away from moving parts. Loose clothes, jewellery or long hair can be caught in moving parts.

g. If devices are provided for the connection of dust extraction and collection facilities, ensure these are connected and properly used. Use of dust collection can reduce dust-related hazards.

4. Power tool use and care

a. Do not force the power tool. Use the correct power tool for your application. The correct power tool will do the job better and safer at the rate for which it was designed.

b. Do not use the power tool if the switch does not turn it on and off. Any power tool that cannot be controlled with the switch is dangerous and must be repaired.

c. Disconnect the plug from the power source and/or the battery pack from the power tool before making any adjustments, changing accessories, or storing power tools. Such preventive safety measures reduce the risk of starting the power tool accidentally.

d. Store idle power tools out of the reach of children and do not allow persons unfamiliar with the power tool or these instructions to operate the power tool. Power tools are dangerous in the hands of untrained users.

e. Maintain power tools. Check for misalignment or binding of moving parts, breakage of parts and any other condition that may affect the power tool's operation. If damaged, have the power tool repaired before use. Many accidents are caused by poorly maintained power tools.

f. Keep cutting tools sharp and clean. Properly maintained cutting tools with sharp cutting edges are less likely to bind and are easier to control.

g. Use the power tool, accessories and tool bits etc. in accordance with these instructions, taking into account the working conditions and the work to be performed. Use of the power tool for operations different from those intended could result in a hazardous situation.

5. Service

a. Have your power tool serviced by a qualified repair person using only identical replacement parts. This will ensure that the safety of the power tool is maintained.

ADDITIONAL SAFETY INSTRUCTIONS FOR YOUR HAMMER

- 1.** Always wear ear protectors. Exposure to noise can cause hearing loss.
- 2.** Always use auxiliary handles supplied with the tool. Loss of control can cause personal injury.
- 3.** Hold power tool by insulated gripping surfaces, when performing an operation where the cutting accessory may contact hidden wiring or its own cord. Cutting accessory contacting a "live" wire may make exposed metal parts of the power tool "live" and could give the operator an electric shock.
- 4.** Safety boots are recommended at all times especially when using the chisel actions.
- 5.** Proper safety gloves are also recommended.
- 6.** When using chisel a dust mask is necessary because of the cement dust created by the action.
- 7.** Always check walls and ceiling to avoid hidden power cables and pipes. A metal detector can be obtained from any good DIY store for this purpose.
- 8.** Use clamps or a vice to hold workpiece, if possible.
- 9.** This heavy duty high torque machine should not be used, while standing on a ladder.
- 10.** Before starting to work always check that the chisel or drill bit is properly locked in the chuck.
- 11.** Hold the tool firmly with both hands while working and provide for secure footing. The tool is more securely guided with both hands.
- 12.** Wait until the machine has come to a standstill before placing it down. The insertion tool can be come caught and lead to loss of control over the machine.
- 13.** The screw of machine can come loose easily, and causing a breakdown or accident. Check tightness of screw carefully before operation.
- 14.** Do not touch the bit or parts close to the bit immediately after operation. They may be extremely hot and could burn your skin.
- 15.** In cold weather or when the tool has not been used for a long time. Let the tool warm up for a while by operating it under no load. This will loosen up the lubrication.
- 16.** Some material contains chemicals which may be toxic. Take caution to prevent dust inhalation and skin contact. Follow material supplier safety data.

HEALTH ADVICE



WARNING! When drilling, sanding, sawing or grinding, dust particles will be produced.

In some instances, depending on the materials you are working with, this dust can be particularly harmful to you (e.g. lead from old gloss paint).

You are advised to consider the risks associated with the materials you are working with and to reduce the risk of exposure. You should:

- Work in a well-ventilated area.
- Work with approved safety equipment, such as those dust masks that are specially designed to filter microscopic particles.

VIBRATION

The European Physical Agents (Vibration) Directive has been brought in to help reduce hand arm vibration syndrome injuries to power tool users. The directive requires power tool manufacturers and suppliers to provide indicative vibration test results to enable users to make informed decisions as to the period of time a power tool can be used safely on a daily basis and the choice of tool.

Further Advice can be found at www.hse.gov.uk

For TTB278SDS	
Work mode description	Vibration total values (triax vector sum) determined according to EN 60745:
For hammer drilling into concrete $a_{h,HD} =$	$18.067m/s^2 + K = 1.5m/s^2$
For chiselling $a_{h,Cheq} =$	$16.878m/s^2 + K = 1.5m/s^2$
For TTB279SDS	
Work mode description	Vibration total values (triax vector sum) determined according to EN 60745:
For hammer drilling into concrete $a_{h,HD} =$	$18.067m/s^2 + K = 1.5m/s^2$
For chiselling $a_{h,Cheq} =$	$16.878m/s^2 + K = 1.5m/s^2$

The declared vibration emission value should be used as a minimum level and should be used with the current guidance on vibration.

Calculating the actual period of the actual period off use can be difficult and the HSE website has further information.

The declared vibration emission has been measured in accordance with a standardised test stated above and may be used to compare one tool with another.

The declared vibration emission value may also be used in a preliminary assessment of exposure.



Warning: The vibration emission value during actual use of the power tool can differ from the declared value depending on the ways in which the tool is used dependant on the following examples and other variations on how the tool is used:-

How the tool is used and the materials being drilled.

The tool being in good condition and well maintained.

The use the correct accessory for the tool and ensuring it is sharp and in good condition.

The tightness of the grip on the handles.

And the tool is being used as intended by its design and these instructions.

This tool may cause hand-arm vibration syndrome if its use is not adequately managed.



Warning: identify safety measures to protect the operator that are based on an estimation of exposure in the actual conditions of use (taking account of all parts of the operating cycle such as the times when the tool is switched off and when it is running idle in addition to the trigger time). Note The use of other tools will reduce the users' total working period on this tool.

Helping to minimise your vibration exposure risk.

ALWAYS use sharp drill bits or chisels.

Maintain this tool in accordance with these instructions and keep well lubricated (where appropriate).

Avoid using tools in temperatures of 10°C or less.

Plan your work schedule to spread any high vibration tool use across a number of days.

Health Surveillance

All employees should be part of an employer's health surveillance scheme to help identify any vibration related diseases at an early stage, prevent disease progression and help employees stay in work.

Double insulation: 

The tool is double insulated. This means that all the external metal parts are electrically insulated from the mains power supply. This is done by placing insulation barriers between the electrical and mechanical components making it unnecessary for the tool to be earthed.

Important note:

Be sure the supply is the same as the voltage given on the rating plate. The tool is fitted with a two-core cable and plug.

Remove the mains plug from socket before carrying out any adjustment or servicing.

Torque limiter:

There is a clutch in your hammer drill. The torque limiter will actuate when a certain torque level is reached. The motor will disengage from the output shaft. When this happens, the bit will stop turning. As soon as the torque limiter actuates, release the trigger and remove the tool and bit immediately. This will help prevent premature wear of the tool.

SYMBOLS



Read the manual



Warning



Waste electrical products should not be disposed of with household waste. Please recycle where facilities exist. Check with your Local Authority or retailer for recycling advice.



Wear ear protection



Wear dust mask



Wear eye protection



Double insulation



Conformity to CE directive

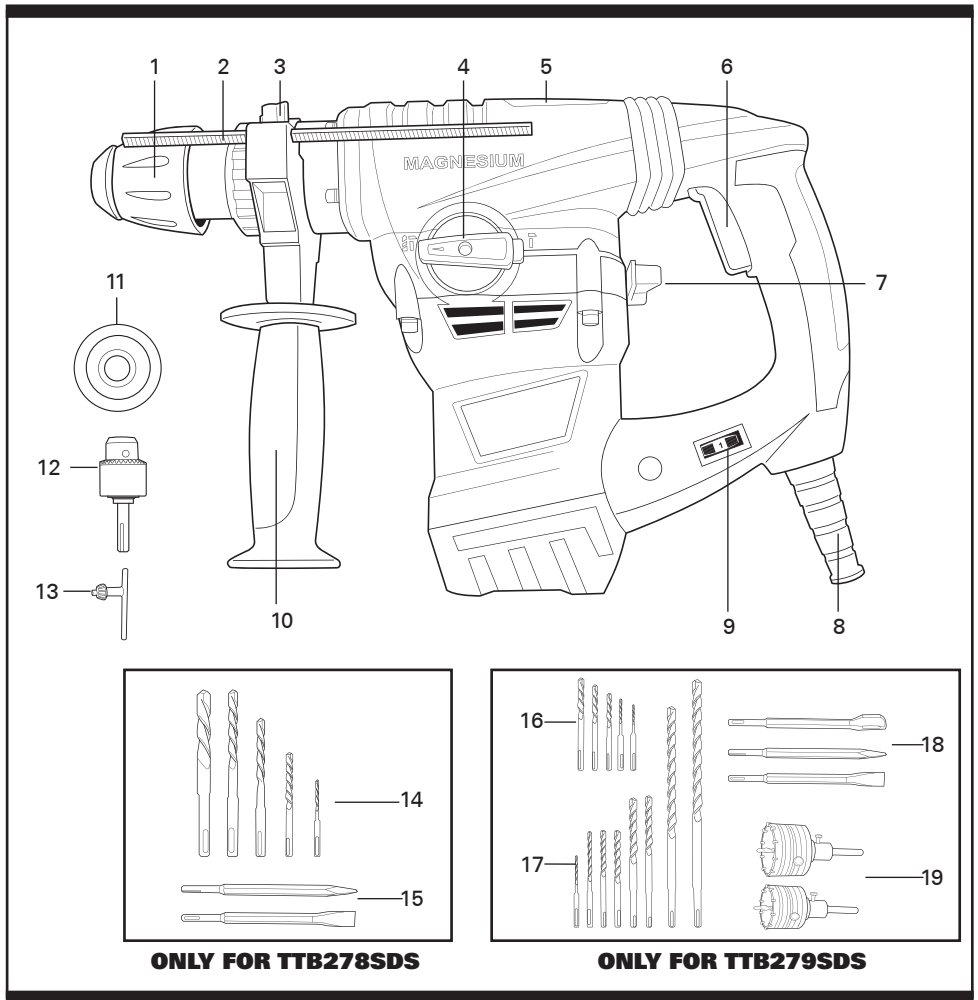

1 FASTENING SLEEVE

2 DEPTH GAUGE

3 DEPTH GAUGE LOCK

4 DIAL SELECTOR WITH LOCK BUTTON

5 GEAR BOX COVER

6 ON/OFF SWITCH

7 LEVER SELECTOR

8 MAINS POWER CABLE

9 VARIABLE SPEED SWITCH

10 AUXILIARY HANDLE

11 DUST COVER

12 KEY CHUCK AND ADAPTOR

13 CHUCK KEY

14 SDS DRILL BITS (6, 8, 10, 12, 14mm)

15 SDS CHISEL BITS (FLAT, POINT)

16 DRILL BITS COATED TI (5, 6, 8, 10, 12mm)

17 SDS DRILL BITS (6, 8, 10, 12, 14, 16, 18, 20mm)

18 SDS CHISEL BITS (U, FLAT, POINT)

19 DIAMOND CORES (65, 80mm)

TECHNICAL DATA

Voltage:	230-240V~ 50Hz
Input power:	1500W
No-load speed:	200-750/min
Impact rate:	800-3000bpm
Drilling capacity:	
Masonry	32mm
Steel	13mm
Wood	40mm
Chuck type:	SDS plus
Protection class:	II
Machine weight:	6.1kg

ROTARY HAMMER 1500W TTB278SDS TTB279SDS

NOISE DATA

A weighted sound pressure	93.8dB(A) / KpA: 3dB(A)
A weighted sound power	104.8dB(A) / KwA: 3dB(A)
Wear ear protection when sound pressure is over	80dB

ACCESSORIES

Auxiliary handle	1pc
Metal depth gauge	1pc
Dust cap	1pc
Keyed chuck with SDS adaptor & chuck key	1pc

ONLY FOR TTB278SDS

SDS masonry drill bits (6, 8, 10, 12, 14mm)	5pcs
Chisels (Flat, Point)	2pcs

ONLY FOR TTB279SDS

SDS masonry drill bits (6, 8, 10, 12, 14, 16, 18, 20mm)	8pcs
Drill bits coated TI (5, 6, 8, 10, 12mm)	5pcs
Diamond cores (65, 80mm)	2pcs
Chisels (U, Flat, Point)	3pcs

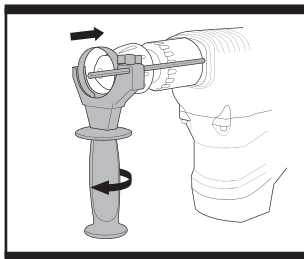

Fig. 1

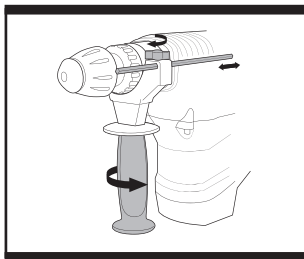

Fig. 2

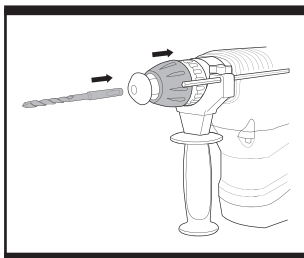

Fig. 3

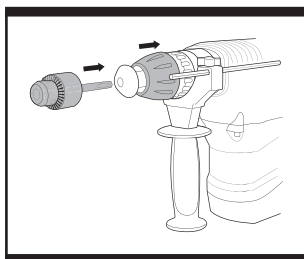

Fig. 4

OPERATIONS INSTRUCTIONS



Note: Before using the tool, read the instruction book carefully.

INTENDED USE

This rotary hammer shall be used for drilling metal or wood or similar materials and for hammer drilling of concrete and masonry and similar materials.

Other uses for the tool will lead to the damage of the tool and a series of dangers to the operator. This tool is intended for DIY home use or occasional professional use.

1. INSTALLING THE AUXILIARY HANDLE

(Fig. 1)

Loosen the handgrip anti-clockwise then slide the handle on the head of the hammer.

Rotate the handgrip clockwise to clamp the handle and tighten fully (Fig. 2).



Warning! For reasons of safety, only use the tool when it is fitted with the auxiliary handle, making sure the auxiliary handle is sufficiently tightened to stop movement in use.

2. INSTALLING THE DEPTH GAUGE

(Fig. 2) Rotate the small knob on the handle anti-clockwise.

Insert the depth gauge through hole in handle to required depth. The depth gauge can be used to set a constant depth to hammer. Rotate the knob clockwise to clamp the depth gauge and tighten fully.

3. INSERTING SDS TOOLS OR CHUCK

(Fig. 3 & Fig. 4)

The hammer is equipped with an SDS-plus attachment system. The chuck/SDS tools have slots in the shank.

These locate with tabs in the rotary hammer. Hold the rotary hammer with one hand facing away from you.

Grip and pull back the fastening sleeve and insert the chuck/SDS tool. Push inwards until a resistance is felt.

Once you are satisfied it has seated release the black fastening sleeve. This should lock the chuck into position.

4. REMOVE SDS TOOLS OR CHUCK

To remove the SDS tools/chuck, pull back fastening sleeve, hold and remove tool.

5. USING THE KEY CHUCK (Fig. 5)

The hammer comes supplied with a drill chuck with a SDS adaptor. This drill chuck is used for drilling on wood or steel. Do not use this drill chuck for hammer drilling or chiselling on any work piece. Fit the drill chuck to the SDS chuck holder as section 3. Turning the chuck key at the three positions will loose or tighten the chuck. Turning the key anti-clockwise to loosen the chuck. Insert the drill bit into the chuck holder then turning the key clockwise firmly to tighten the drill bit.

Warning: DO NOT use the key chuck for hammer drilling action or chiselling action! Remove the key from the chuck before starting the tool!

6. VARIABLE SPEED SWITCH (Fig. 6)

The speed increases as you turn the switch towards the higher number and decreases on the lower number.

7. HAMMER DRILL FUNCTION (Fig. 7 & Fig. 8)

Adjust the dial selector to position  **T** to provide rotation of the chuck.

Adjust the lever selector to position  **T** to provide the hammer action.

You are now set up for hammer drilling into masonry or concrete etc.

Note: Press the lock button (a) before adjusting the dial selector. If the selector switch can't go into the required position, switch on your hammer a little, then adjust the selector again.

8. DRILLING FUNCTION

Adjust the dial selector to position  **T** to provide rotation of the chuck.

Adjust the lever selector to position  to stop the hammer action.

You are now set up for drilling into wood or metal.

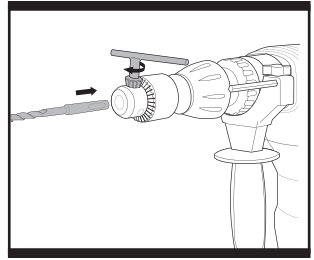

Fig. 5

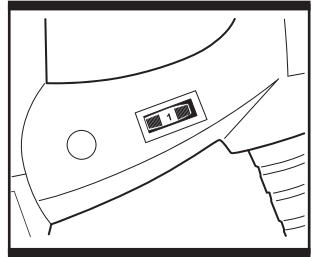

Fig. 6

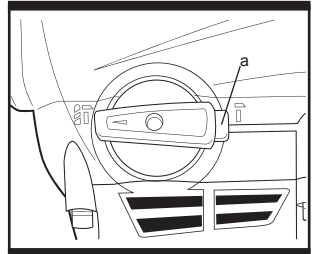

Fig. 7

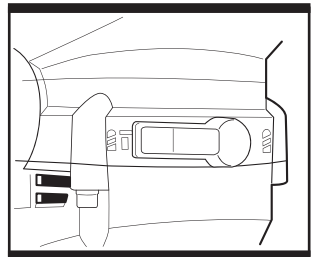

Fig. 8

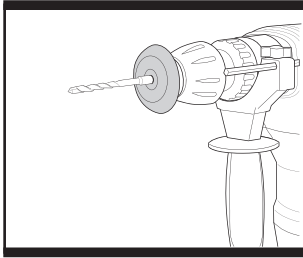

Fig. 9

9. HAMMER FUNCTION

Adjust the dial selector to position **T** to stop rotation of the chuck.

Adjust the lever selector to position **T** to provide the hammer action.

You are now set up for chisel work using hammer action.

10. DUST COVER (Fig. 9)

The dust cover shall be used to protect the user and the tool from dust, in particular when drilling into the ceiling. Slide the dust cover on the drilling accessory down to the chuck.

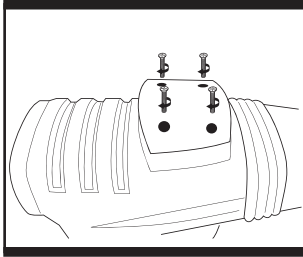

Fig. 10

11. LUBRICATION OF THE TOOL (Fig. 10)

Always check there is sufficient grease in the grease box before usage. Check every 5 hrs of use. Open the grease box lid at the top of the hammer by removing the four screws with a screwdriver.

Then top up the grease box (capacity 20gms max) using general purpose lithium based grease.

WORKING HINTS

Always use sharp good quality drill bits and chisels. The performance of the drill is dependant on the quality of the bits used.

- Reduce the pressure on the drill bit when it is about to break through. This will prevent the drill from jamming.
- When drilling a large hole, first drill a pilot hole using a smaller drill bit.
- Always apply pressure to your drill bit in a straight line, and if possible at right angles to the workpiece.
- When drilling holes into walls, floors etc., always make sure that there are no live electrical wires, or pipe work in the path of the bit.
- Always operate your drill using both the handle and the front handle.
- Never change the operating mode whilst the drill is running.
- When using the product in the hammer only mode, or when chiselling masonry, make sure that you wear safety glasses and protective gloves.
- Do not apply excessive pressure to the tool when chiselling. Excessive force does not speed up the work.

MAINTENANCE

Remove the plug from the socket before carrying out any adjustment, servicing or maintenance.

Your power tool requires no additional lubrication or maintenance. There are no user serviceable parts in your power tool. Never use water or chemical cleaners to clean your power tool. Wipe clean with a dry cloth. Always store your power tool in a dry place. Keep the motor ventilation slots clean. Keep all working controls free of dust. Occasionally you may see sparks through the ventilation slots. This is normal.

If the supply cord is damaged, it must be replaced by the manufacturer, its service agent or similarly qualified persons in order to avoid a hazard.

ENVIRONMENTAL PROTECTION



Waste electrical products should not be disposed of with household waste. Please recycle where facilities exist. Check with your Local Authority or retailer for recycling advice. For further information visit www.recyclenmore.co.uk

UK PLUG REPLACEMENT

The fuse in the main plug of your power tool should always be replaced with one of identical rating.

Check the voltage given on your power tool matches the supply voltage.

The power tool is supplied with a fitted plug, however if you should need to fit a new plug follows the instruction below.

IMPORTANT

The wire in the mains lead are coloured in accordance with the following code:

Blue ---Neutral

Brown ---Live

The wire that is coloured **blue** must be connected to the terminal that is marked with the letter **N**. The wire that is coloured **brown** must be connected to the terminal that is marked with the letter **L**.

A 13AMP (BS1363 or BS1363/A) plug must be used and a 13 AMP fuse must be fitted.

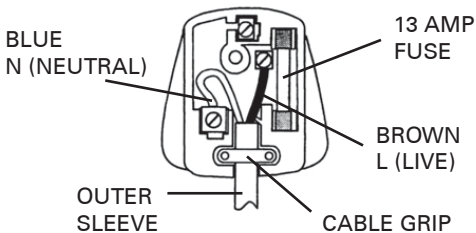

TITAN®

Declaration of Conformity

We, Importer
Titan Power Tools (UK) Ltd
Trade house, Mead Avenue, BA22 8RT

Declare that the product:

Designation: ROTARY HAMMER 1500W
Model: TTB278SDS & TTB279SDS

Complies with the following Directives:

2004/108/EC Electromagnetic Compatibility Directive

2006/42/EC Machinery Directive

2006/95/EC Low Voltage Directive

2002/95/EC Restrictions of the Use of Certain Hazardous Substances in Electrical and Electronic Equipment
2002/96/EC and **2003/108/EC** Waste Electrical and Electronic Equipment (WEEE)

Standards and technical specifications referred to:

EN 60745-1: 2009

EN 60745-2-6: 2003+A1:2006+A11:2007+A2:2009+A12:2009

EN 55014-1: 2006+A1: 2009

EN 55014-2:1997+A1: 2001+A2: 2008

EN 61000-3-2: 2006

EN 61000-3-3: 2008

Authorised Signatory and technical file holder

Date: 07/07/2010

Signature: P.C. Harries

Name / title: Peter Harries / Quality Manager

Titan Power Tools (UK)Ltd. Trade House , Mead Avenue ,BA22 8RT

