

Mira Advance ATL (1643) (J97A-H, J97P)

ADJUSTABLE TEMPERATURE LIMIT THERMOSTATIC

9.0 and 9.8 kW

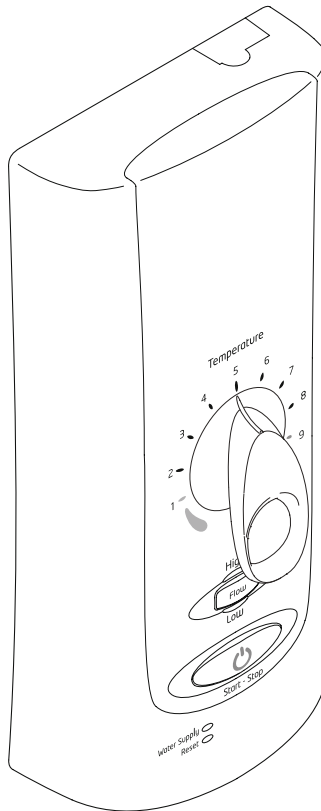

Important! This product is suitable for mains fed cold water only.

Installation Guide

Showering perfection

mira
SHOWERS

CONTENTS

Shower Models	4
Guarantee	4
Patents and Design Registration.....	5
Important Safety Information	5
Warning	5
Caution	6
Pack Contents	7
Specifications	8
Standards and Approvals	8
Dimensions.....	9
Installation Requirements	9
General.....	9
1. Plumbing	10
2. Electrical.....	11
Installation	14
Priming the Shower	15
Mira Advance Shower Models for use with the Instantmatch by Whale® Digital Pump	17
Electrical Schematic Diagram (Drain Pump).....	17
Instantmatch by Whale® Digital Pump	19
Wireless Installation	20
Wireless Signal Schematic Diagram	20
Drain Pump Registration	21
Drain Pump Test.....	21
Registration or Test Failure	22
Basic Post Installation Checks	23
Commissioning	24
Set Maximum Temperature and Commissioning Cycle.....	24
Commissioning Failures	25
BEAB Care	26
Memory Model.....	26

If you experience any difficulty with the installation or operation of your new Electric Shower, then please refer to '**Fault Diagnosis**', before contacting Mira Showers. Our contact details can be found on the back cover of this guide.

Fault Diagnosis	27
1. Installer Troubleshooting Guide.....	27
2. Diagnostic Procedure	28
BEAB Care In-Service Tests	33
Maintenance	35
Spare Parts and Accessories	36
Wiring Diagram	38
BEAB Care In-Service Test Record	39
Customer Service	Back Cover

SHOWER MODELS

Mira Advance ATL models covered by this guide

Product Variant	Adjustable Temperature Limit	Memory Push Button Feature	Extended Lever Control	Drain Pump Compatible	Model No.
Standard 9.0 kW	✓	✗	✗	✗	J97A
Standard 9.8 kW	✓	✗	✗	✗	J97B
Flex 9.0 kW	✓	✗	✓	✗	J97C
Flex 9.8 kW	✓	✗	✓	✗	J97D
Memory 9.0 kW	✓	✓	✗	✗	J97E
Memory 9.8 kW	✓	✓	✗	✗	J97F
Standard Extra	✓	✗	✗	✓	J97G
Flex Extra	✓	✗	✓	✓	J97H
Flex Extra Wireless	✓	✗	✓	✓	J97P

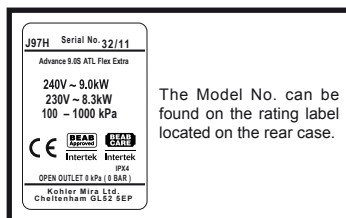

The 'Extra' models (J97G, J97H and J97P) feature a dedicated hardwire or wireless connection to a shower drain pump.

The following shower drain pump kit is compatible for 'wireless' connection:

SDP134T - Instantmatch by Whale®

Guarantee

For **domestic installations**, Mira Showers guarantee the Mira Advance ATL against any defect in materials or workmanship for a period of **two years** from the date of purchase (shower fittings for one year).

For **non-domestic installations**, Mira Showers guarantee the Mira Advance ATL against any defect in materials or workmanship for a period of **one year** from the date of purchase.

For Terms and Conditions refer to the back cover of this guide.

Recommended Usage	
Domestic	✓
Light Commercial	✓
Heavy Commercial	✗
Healthcare	✓

Patents and Design Registration

Design Registration:	000738141: 0003, 0006, 0007, 0009
Patents:	GB: 2269466, 2270370, 2298478, 2298479, 2298481

IMPORTANT SAFETY INFORMATION

Installation must be carried out in accordance with these instructions, and must be conducted by designated, qualified and competent personnel.

WARNING!

Follow all warnings, cautions and instructions contained in this guide, and on or inside the shower.

- This shower can deliver scalding temperatures if not installed or maintained in accordance with the instructions, warnings and cautions contained in this guide and on or inside the appliance.**
- This product is suitable for installation within Zone 1 and is rated IPX4.
- Isolate the electrical and water supplies before commencing installation. The electricity must be turned off at the mains and the appropriate circuit fuse removed, if applicable.
- Mains connections are exposed when the cover is removed.
- Refer to the wiring diagram before making any electrical connections.
- Make sure all electrical connections are tight, to prevent overheating.
- Make sure that any pipework that could become frozen is properly insulated. The shower unit must not be fitted where it may be exposed to freezing conditions.
- The water supplies to this product must be isolated if the product is not to be used for a long period of time. If the product or pipework is at risk of freezing during this period they should also be drained of water.
- DO NOT** operate this appliance if it is frozen. Isolate the electrical supply and allow to thaw. Check for leaks before reconnecting the electrical supply.
- DO NOT** install the product in a position in which service access is restricted.
- If the shower is dismantled during installation or servicing then upon completion the product must be inspected to ensure there are no leaks.

12. **DO NOT** fit any form of outlet flow control (e.g. trigger handsets) as the outlet acts as a vent for the tank body. Only Mira recommended outlet fittings should be used.
13. This product is not suitable for areas with high humidity (i.e. steam rooms).
14. **THIS APPLIANCE MUST BE EARTHED. MAKE SURE SUPPLEMENTARY BONDING COMPLIES WITH THE 'REQUIREMENTS FOR ELECTRICAL INSTALLATIONS' BS7671.** This electric shower is intended to be permanently connected to the fixed electrical wiring of the mains system.
15. This appliance must be provided with means for disconnection that is incorporated into the fixed wiring in accordance with the relevant local wiring regulations.
16. This appliance is suitable for installation within the shower area. It must be positioned over a water catchment area with the controls at a convenient height for the user. The shower fitting should be positioned so that it discharges down the centre line of the bath, or across the opening of a shower cubicle, and **must be directed away from the appliance.**
17. **DO NOT** tile up to the sides of the shower or use sealant around the case (see section '**Installation Requirements**').

CAUTION!

1. Read all of these instructions and retain this guide for later use.
2. The electrical installation must comply to 'BS 7671 (commonly referred to as the IEE Wiring Regulations) and all relevant building regulations, or any particular regulation or practice specified by the local electricity supply company.
3. The plumbing installation must comply with all national or local water regulations and all relevant building regulations, or any particular regulation or practice specified by the local water company or water undertakers.
4. Switch off the appliance at the electrical isolating switch when not in use. This is for safety and is recommended with all electrical appliances.
5. This appliance is not suitable for use with any form of electronic timer. The shower must be shut down in accordance with the instructions contained in this installation guide, or the separate user guide.
6. Having completed the installation, make sure that the user is familiar with the operation of the appliance.
7. When this appliance has reached the end of its serviceable life, it should be disposed of in a safe manner, in accordance with current local authority recycling, or waste disposal policy.
8. Please pass this guide on in the event of a change of ownership of the installation site.

PACK CONTENTS

Tick the appropriate boxes to familiarise yourself with the part names and to confirm that the parts are included.

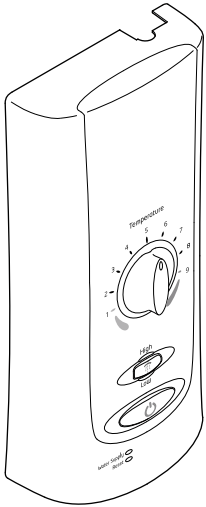

Or

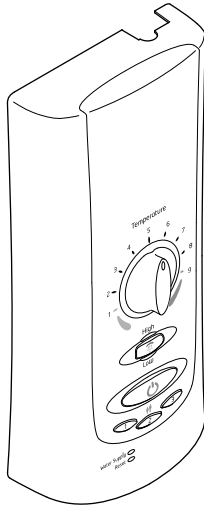

Or

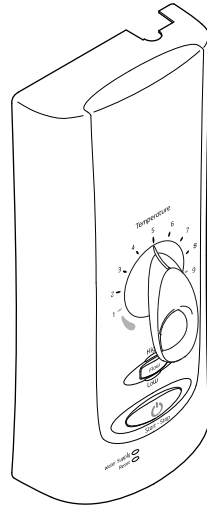

1 x Mira Advance ATL
Standard or Standard Extra
(Instantmatch by Whale®
Pump supplied separately)

1 x Mira Advance ATL
Memory

1 x Mira Advance ATL
Flex or Flex Extra
(Instantmatch by Whale®
Pump supplied separately)

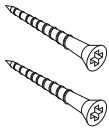

2 x Fixing Screws

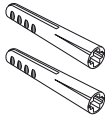

2 x Wall Plugs

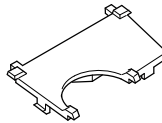

1 x Cover
Insert Top

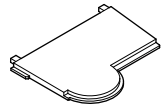

1 x Cover / Pipe
Insert Top



1 x Compression Nut



1 x Olive

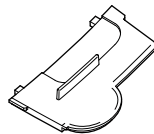

1 x Cover
Insert Bottom

Documentation

- 1 x Installation Guide
- 1 x User Guide
- 1 x Installation Template
- 1 x Guarantee Registration Document

SPECIFICATIONS

Plumbing Supply	Supply Source	Mains pressure cold water only		
	Minimum Dynamic Pressure*	50 kPa (0.5 bar) (100 kPa (1 bar) BEAB Care)		
	Maximum Dynamic Pressure	500 kPa (5.0 bar)		
	Maximum Static Pressure	1000 kPa (10 bar)		
	Minimum Static Pressure**	20 kPa (0.2 bar)		
	Maximum Inlet Temperature	30°C (20°C BEAB Care)		
	Minimum Inlet Temperature	2°C (5°C BEAB Care)		
	Inlet Connection	½" BSP male & 15 mm compression fitting.		
	Outlet Connection	½" BSP male fitting		
Electrical Supply	Nominal Rating at 230 V	8.3 kW	9.0 kW	
	Nominal Rating at 240 V	9.0 kW	9.8 kW	
	Supply Fuse/Circuit Breaker	9.0 kW	40 Amps	
		9.8 kW	45 Amps	
	Residual Current Device RCD	30 mA		
	Supply Cable	No larger than 16 mm ² Note: Refer to current IEE regulations and BS 7671 to determine minimum cable size.		
Isolation Switch	45 Amp Double pole, with 3 mm contact separation.			
Maximum Ambient Temperature		30°C		
Minimum Ambient Temperature		2°C		

* Recommended dynamic pressure of 100 kPa (1.0 bar) for full flow performance.

** Static pressure must never fall below 20 kPa (0.2 bar) when other draw offs are in use, e.g. flushing toilet. This is the minimum pressure required to keep the flow valve closed.

Standards and Approvals

The Mira Advance ATL complies with the requirements of the BEAB Care Mark Standard and the relevant directives for CE marking.

The BEAB Care mark is invalid if the product is not installed and used in accordance with the manufacturer's specifications and instructions.

The Mira Advance ATL Flex Extra Wireless (J97P) is in compliance with the essential requirements and other relevant provisions of the R&TTE directive 1999/5/EC. A copy of the declaration of conformity may be obtained by contacting Kohler Mira Ltd UK customer services department. See back cover for details.

Dimensions

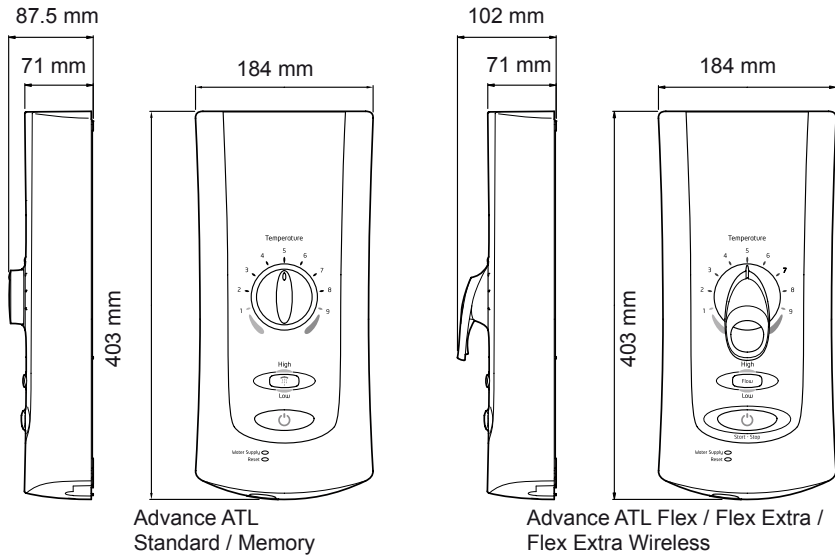

INSTALLATION REQUIREMENTS

General

We recommend that the product be brought into the room where it is to be installed and left to acclimatise to room temperature, this will reduce the possibility of condensation on electronic components.

The shower works best when water supply conditions are stable and within the specifications, refer to section '**Specifications**'. If the supply conditions fall outside the specifications, the shower may go into a safe shut down condition.

IT IS DANGEROUS to connect the outlet of the shower to any tap, on/off control valve, trigger operated showerhead or any other showerhead other than those specified for use with this shower. This could cause scalding or severe damage to the product and will invalidate the guarantee. Only Kohler Mira recommended showerheads, shower hoses and accessories must be used.

If pipework and/or electrical cables enter the shower from the rear through a hole in the wall, provision must be made to prevent water ingress back into the wall structure. Route cable and pipe supplies via the cut outs moulded in the case and cover.

IT IS DANGEROUS to perform any unspecified modifications to the shower or its accessories. Drilling fixing holes or making water or electrical entry points outside of the showers designed areas can lead to uncontrolled water ingress. This could cause fire, electrocution or damage to the product and will invalidate the product guarantee. When servicing only use genuine Kohler Mira replacement parts.

DO NOT increase the size or cut alternative pipe / cable entry points as water ingress into the product may occur.

1. Plumbing

Refer to section: '**Important Safety Information**' first.

- 1.1 Do not use sealing compounds on any pipe fittings or joints.
- 1.2 To avoid damage to the case when soldered fittings are used, pre-solder the pipework and fittings before connecting them to the inlet connector assembly.
- 1.3 Never fit the appliance to hot water supplies or to gravity systems of any description. Only fit the product to a mains cold water pipe.
- 1.4 If the pressure exceeds the maximum specified then a drop tight pressure reducing valve (PRV) must be fitted. This should be sited as close to the incoming mains stopcock and ideally set to 3.5 bar.
- 1.5 Avoid layouts where the shower hose will be sharply kinked. This may reduce the life of the hose.
- 1.6 Supply pipework **MUST** be flushed to clear debris before connecting the appliance. Debris will reduce the performance of the shower and may damage the product.
Avoid running the pipework through excessively hot or cold areas such as hot loft spaces, airing cupboards, or in close proximity to hot water pipes. If this cannot be avoided, we would recommend insulating the pipes.
- 1.7 The shower must be fitted onto a tiled or sealed finished surface, i.e. on top of the tiles: **[DO NOT** tile up to the sides of the shower or use a sealant around the case.] Failure to do this may cause appliance failure. To ensure the case and other components are not put under strain during installation always provide mechanical support when making plumbing connections. Upon completion of the installation ensure connections and back case are not under any stress due to misaligned pipework or electrical cables.
- 1.8 We recommend that a non-restrictive (free flowing) isolating valve is fitted in the cold water supply pipe to allow maintenance of the appliance.
- 1.9 When installed in very hard water areas (above 200 ppm temporary hardness) your installer may advise the installation of a water treatment device, to reduce the effects of limescale formation. Any malfunction due to limescale is not covered by the manufacturer's guarantee. Your local water company will be able to advise the hardness of water in your area.
- 1.10 The position of the shower and shower fittings must provide a minimum gap of 25 mm between the showerhead and the spill over level of any bath, shower tray or basin and a minimum gap of 30 mm between the showerhead and the spill over level of any toilet, bidet or other appliance with a Fluid Category 5 backflow risk.

Note! There will be occasions when the hose retaining ring will not provide a suitable solution for Fluid Category 3 installations, in these instances an outlet double checkvalve must be fitted, this will increase the required supply pressure typically by 10kPa (0.1 bar). Double checkvalves fitted in the inlet supply to the appliance cause a pressure build up, which affect the maximum static inlet pressure for the appliance and must not be fitted. For Fluid category 5 double checkvalves are not suitable.

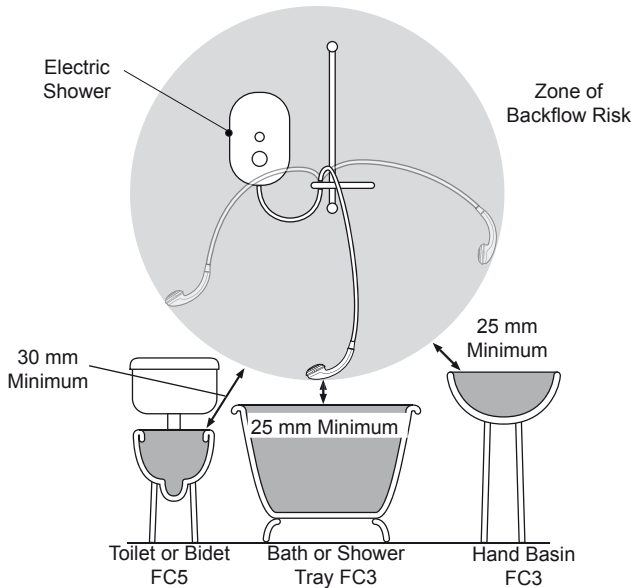

Hose Retaining Ring fitted and shower fittings fixed at a suitable height preventing dirty water backflow.

1.11 Wall fixings are supplied for solid wall structures. For other wall structures such as panels alternative fixings may be required. A minimum of 2 fixing screws must be used.

2. Electrical

Refer to section: '**Important Safety Information**' first.

2.1 In a domestic installation, the rating of the electricity supplier's fuse and the consumer unit must be adequate for the additional demand. All Mira Advance ATL electric showers are high power appliances. Voltage drop due to local heavy demand will reduce the shower's performance.

2.2 The appliance must be earthed by connecting the supply-cable earth conductor to the earth terminal.

Any supplementary bonding and supply cable size must conform to **BS 7671**.

2.3 As a guide only, and in accordance with **BS 7671** we recommend close circuit protection:

i.e. **9.0 kW = 40 Amp**

9.8 kW = 45 Amp

In accordance with **BS 7671**, a 30 mA Residual Current Device (RCD) **MUST** be included in the electrical circuit. This may be part of the consumer unit or a separate unit.

A separate, permanently connected supply must be taken from the consumer unit to the appliance through a double-pole switch, which has at least 3 mm contact separation. The switch can be a ceiling mounted pullcord type within the shower room or a wall mounted switch in the applicable zone area.

- 2.4 DO NOT** exert strain on the terminal block. Make sure that the electrical connections are tightly screwed down.
- 2.5 DO NOT** turn on the electrical supply until the plumbing has been completed.
- 2.6** Unless otherwise stated, electrical equipment such as extractor fans, pumps must not be connected via this product.

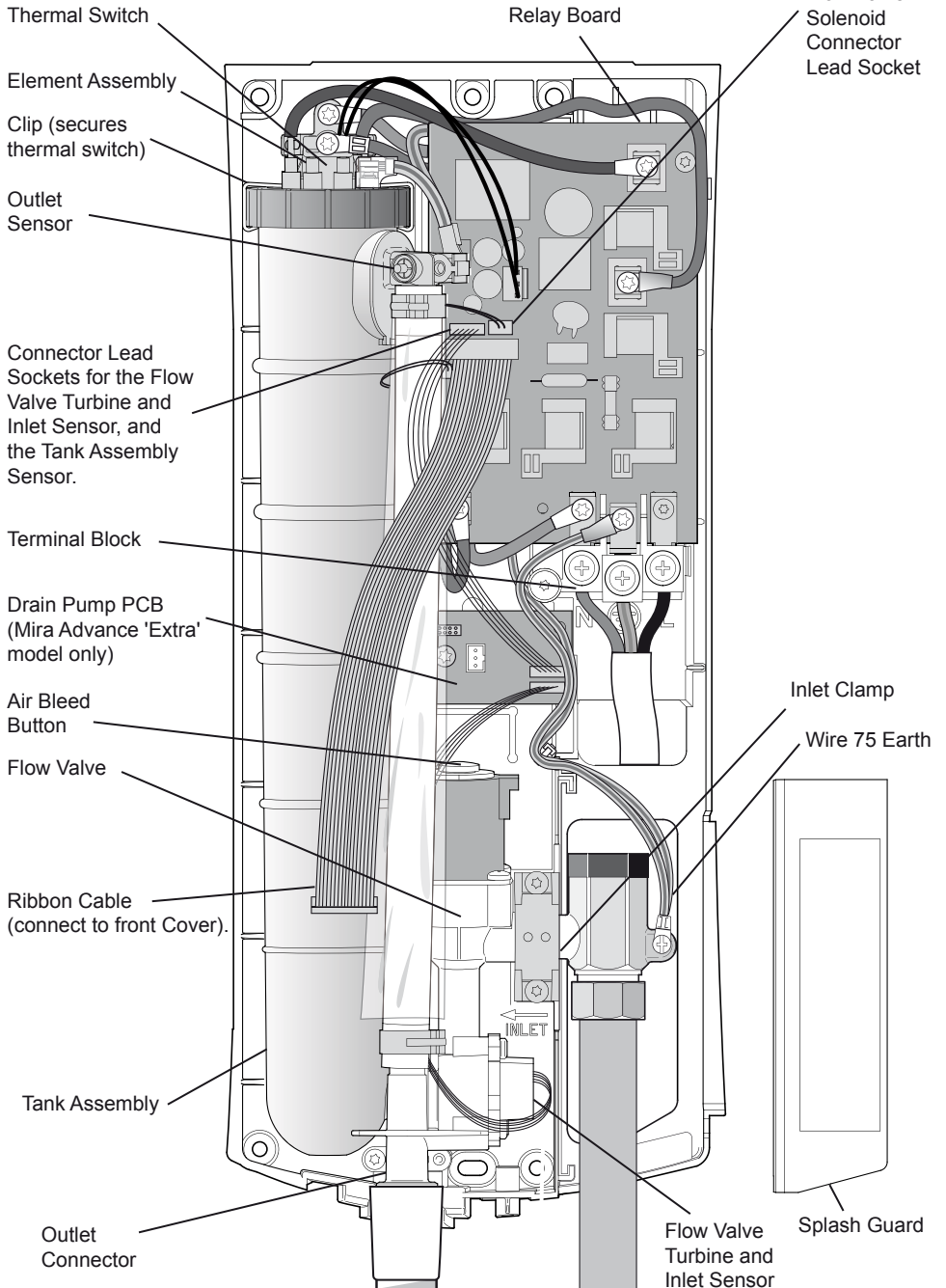

Mira Advance ATL

INSTALLATION

Refer to section: 'Important Safety Information' first.

This installation covers all models of the Mira Advance ATL Thermostatic shower.



1. Electrical supply is turned off at the mains.

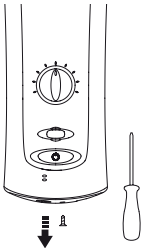

3. Remove cover screw.

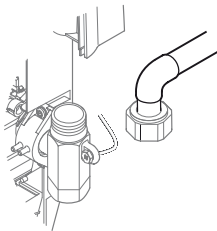

6. Complete any soldering required away from appliance.

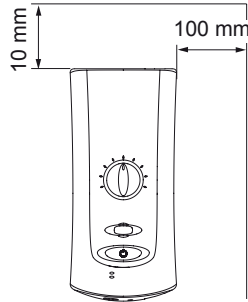

2.

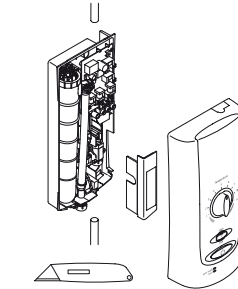

4. Remove cover and splash guard. Determine cable and pipe supply routes via cutouts moulded in the case and cover

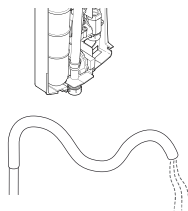

7. Flush a minimum of 10 litres (2 gallons) through pipework prior to connection.

Decide on shower position, leaving adequate space for maintenance.

(If installation includes an Instantmatch by Whale® drain pump, see "Wireless" section for information on position of wireless devices.)

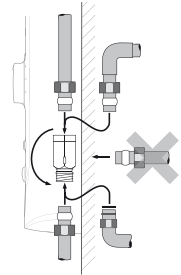

5. Turn inlet connector to suit supply pipe. **Do not** trap green wire.

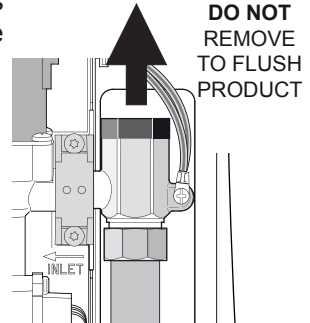

8. **DO NOT** flush through the product by removing the inlet filter. Debris may damage the product and invalidate the guarantee

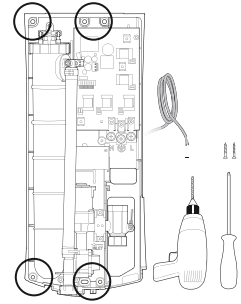
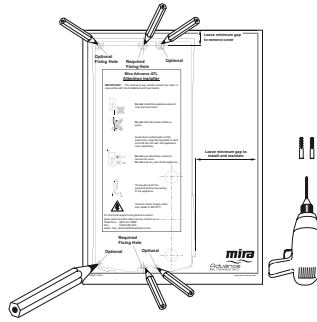
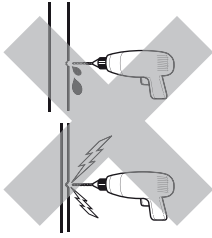

9. **Caution!** Do not drill into buried cables or pipes.

10. Use template provided to mark and drill required fixing holes. **Do not** drill through the plastic case into the wall. Plaster and brick dust will damage internal components.,

11. Drill holes through plastic case as required. Route signal cable to shower drain pump (if applicable). Fix appliance to wall. Use appropriate screws and wall plugs for fixing.

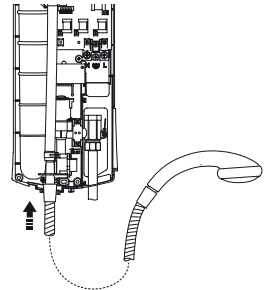
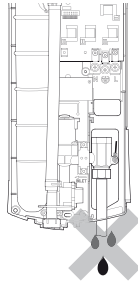
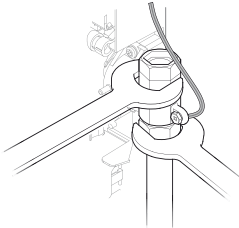

12. Connect supply pipe. **Do not** overtighten.

13. Turn on water supply and check for leaks.

14. Connect hose and showerhead, pointing into bath or tray.

15. **Important! Priming the Shower**
Make sure electricity is isolated!
 Push down and hold air bleed button to prime appliance until water flows from shower head for a minimum of 10 seconds, repeat 3 times. **Failure to prime will seriously affect shower performance!**
Carefully dry off water before connecting / reinstating electricity.

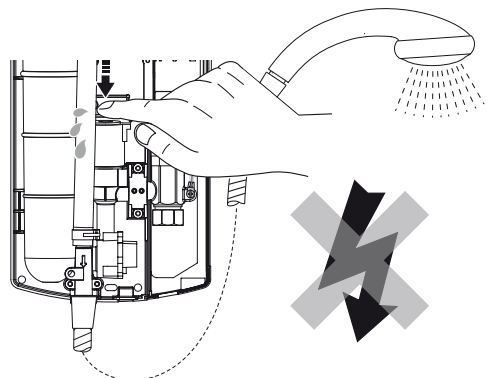

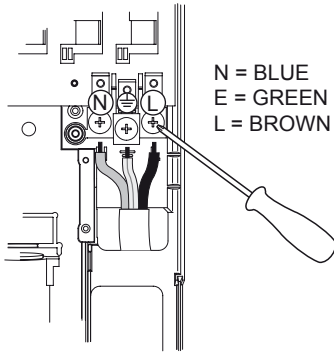

16. Feed cable into case. Firmly connect conductors. **DO NOT** exert strain on terminal block.

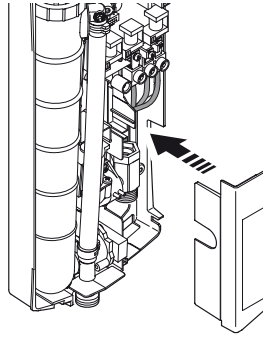

17. Refit splash guard.

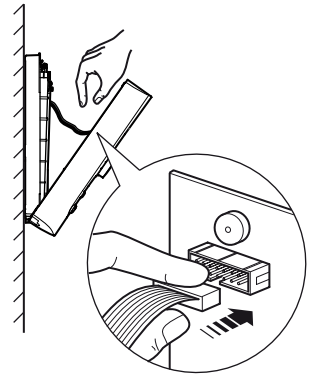

18. Connect ribbon cable to inside of cover.

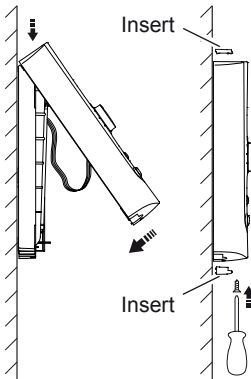

19. Refit cover. Inserts are provided to finish top and bottom as required.

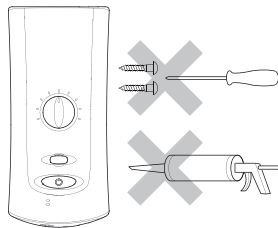

20. Do not use alternative screws to secure cover. This can cause internal damage to appliance. Do not seal around any part of appliance.

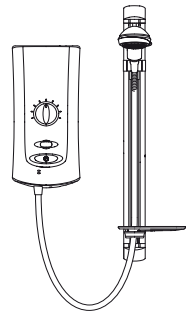

21. Install shower fittings. Refer to separate Installation and User Guide.

Mira Advance Shower Models for use with the Instantmatch by Whale® Digital Pump

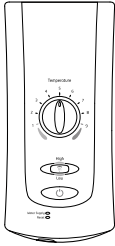

Standard Extra
J97G*

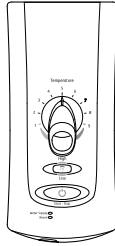

Flex Extra
J97H*

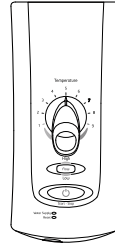

Flex Extra Wireless
J97P*

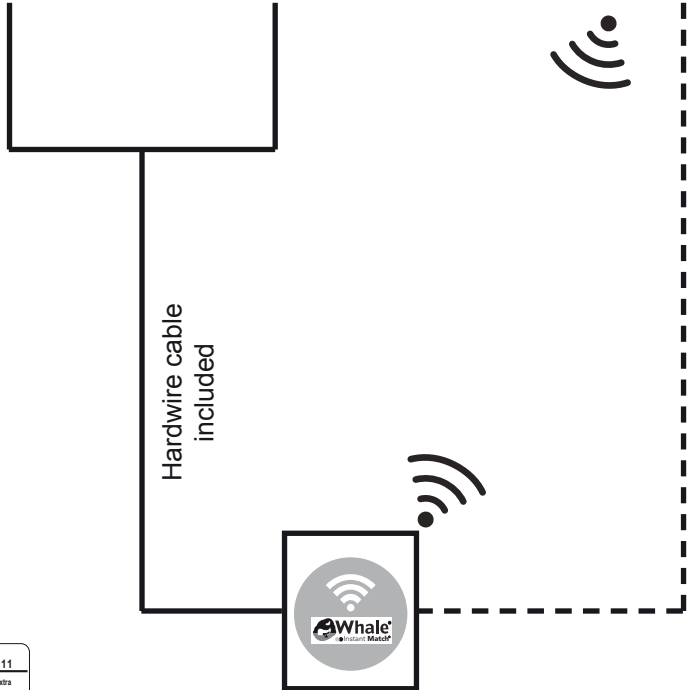

Instant Match
transformer

* The model number can be found on the rating label located on the rear case.

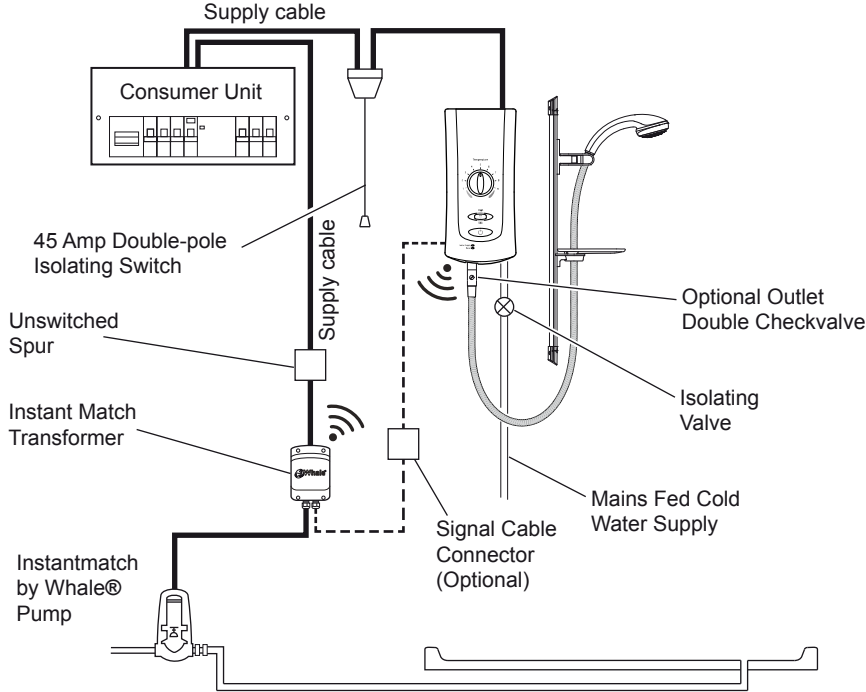

Electrical Schematic Diagram (Drain Pump)

Instantmatch by Whale® Digital Pump

The Mira Advance ATL 'Extra' models can be connected to the Instantmatch by Whale® Pump. This section describes how to identify and connect the shower to the drain pump. For full installation instructions of the Instantmatch by Whale® Pump, see separate guide.

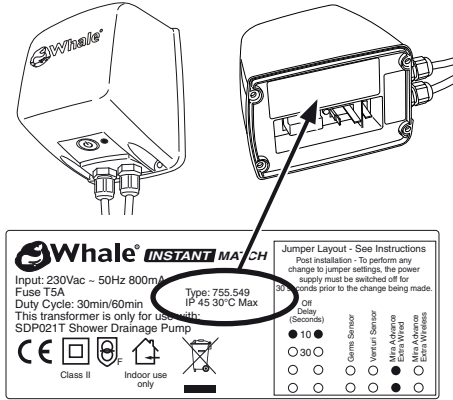

Drain Pump	Shower	
	Driver	Signal
755.171	LK1	Hardwired
755.199	LK1	Hardwired
755.299	LK2	Hardwired
755.349	LK2	Hardwired
755.399	LK2	Hardwired
755.449	LK2	Hardwired
755.549	LK2	Hardwired/ Wireless

TYPE

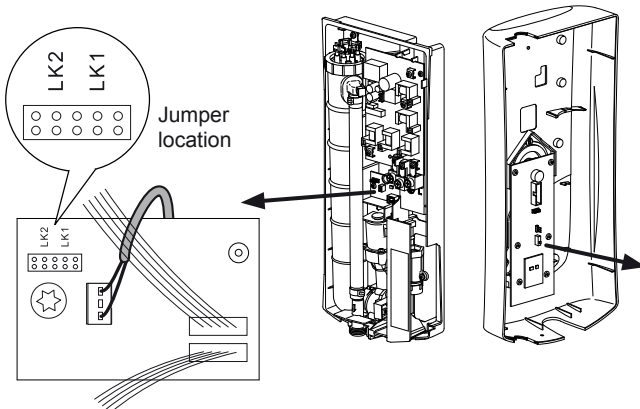

DRIVER

SIGNAL

(Mira Advance Flex Extra Wireless J97P only.)

- Set the electronic jumper positions of the **DRIVER** and **SIGNAL** in the shower according to the **TYPE** number of the drain pump

Wireless Installation (Flex Extra Wireless J97P model only)

1. The wireless version of the Instantmatch by Whale® Pump is connected to the Mira Advance ATL 'Extra' Wireless shower model with a radio signal.
2. For optimum signal strength, site the pump transformer as close to the shower as possible. See the '**Wireless Signal Schematic Diagram**' for shower and drain pump positions.
3. Metal objects such as steel baths or sinks, cold water storage tanks, hot water cylinders, foil lined plaster board walls, radiators and even thick brick walls, can all reduce the operational range of any radio controlled product dramatically. Interference from other radio signals can also reduce the ability of the shower and drain pump to register or communicate. These may include; mobile phones, radio control boiler thermostats, wireless broadband routers, radio control toys, cordless phones, remote outdoor weather stations, panic alarm phone alerts etc. If you encounter difficulty registering the drain pump to the shower make sure all other radio interference is temporarily switched off.

Note! Failure to follow these guidelines can result in poor, intermittent or complete failure to communicate with the drain pump.

4. Install the drain pump in accordance with the separate installation guide supplied.
5. Register the drain pump to the shower. See section '**Drain Pump Registration**'.

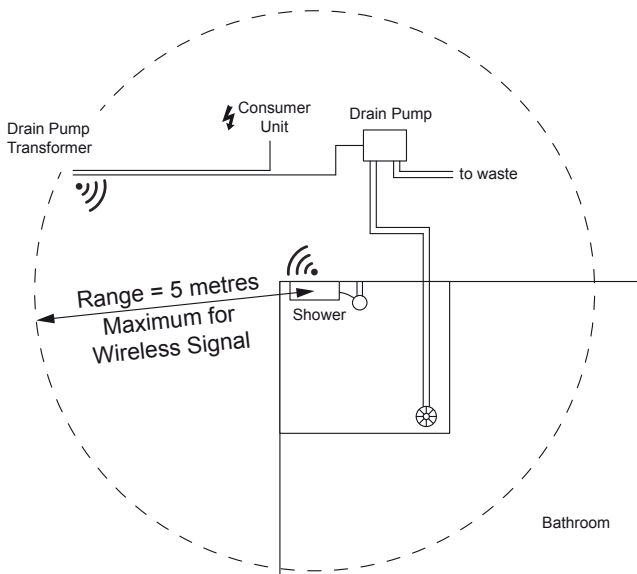

Wireless Signal Schematic Diagram
(for Instantmatch by Whale® Pump)

Drain Pump Registration (Flex Extra Wireless J97P model only)

The shower must register a wireless signal to the drain pump then establish a reliable connection. If you encounter difficulty registering the shower to the drain pump, make sure all electronic devices that could be causing signal interference are temporarily switched off.

1. Set shower temperature to **FULL COLD**.

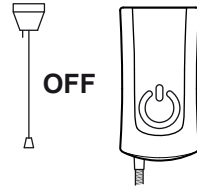
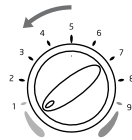

2. Shower is **OFF**.

NO water is flowing.

Power/Electric to shower is **OFF**.

Power/Electric to pump is **ON**.



3. Turn Power/Electric to shower **ON**.

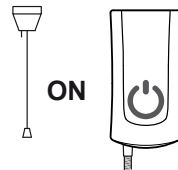

4. Within 30 seconds push and hold **PUMP SWITCH** until 'Beep' from shower and pump switch power light changes colour from **RED/GREEN** to **GREEN** to indicate successful registration.

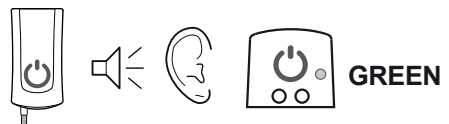

Drain Pump Test

5. Shower temperature to **FULL COLD**.

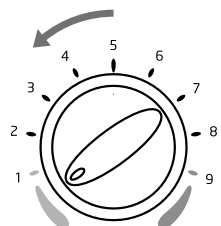

6. Press **START/STOP**.



7. Shower will **START**.



8. Pump will **START**. Any delay will depend upon the plumbing layout, but pump should start within **10 SECONDS**.



9. Pump and shower work normally.

A test failure is indicated by the following:

- Shower and pump stop.
- 1 beep and all lights flash 6 times.



Start - Stop



Registration or Test Failure

- See **'Wireless Installation'** for examples of devices/objects that could be causing signal interference. Make sure all such devices are temporarily switched off, then reregister using the instructions below and retest the drain pump.
- Attempt to improve the signal strength by moving the drain pump transformer, then reregister using the instructions below and retest.
- Shower **STARTS**, but drain pump is **NOT RUNNING**.
*Solution.....*Isolate power and remove shower cover. Check jumper position inside shower cover is set to **WIRELESS**.
- Drain pump **STARTS**, but shower is **NOT RUNNING**.
*Solution.....*Shut down shower and drain pump and reregister using the instructions below. 
- If there is signal interference when other devices are turned back on. Please see Installer Trouble shooting (for drain pump only), to find information on how to change signal frequency.
 1. Power to shower **OFF**.
 2. Push and hold **PUMP SWITCH** until light goes from **GREEN** to **RED/GREEN**.
 3. Within 30 seconds turn power to shower **ON**.
 4. Beep from shower.
 5. **PUMP SWITCH** light changes to **GREEN**.
 6. Turn on shower to confirm shower and pump are operating together.

Basic Post Installation Checks

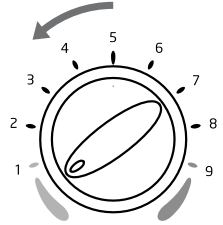
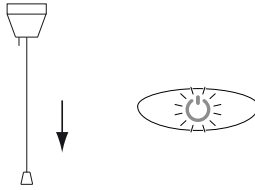

1. Turn on electrical supply.
2. Power to appliance, check **Start/Stop** for blue light.
3. Temperature to full cold.

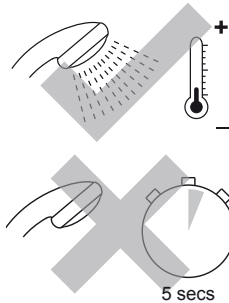

4. Start shower to test for water flow. If a shower drain pump is fitted, it should also start.
5. If there is no water after 5 seconds, make sure that appliance has been **primed**.
6. Push **Start/Stop** to turn off appliance. Pulsing light and "beep" indicates that appliance is shutting down.

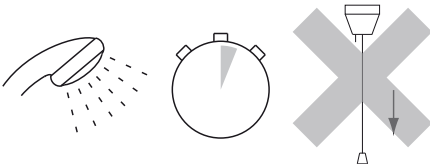

7. Appliance will purge water from heater tank for a few seconds.
Important! DO NOT isolate power until water has stopped.
Go to section: "**Commissioning**".

COMMISSIONING

On initial installation, the appliance needs to 'learn' about the site conditions and does so during the commissioning cycle.

Once set, the shower constantly updates it's memory with information about the site conditions to deliver the best performance.

DO NOT commission the appliance if water leaks from the unit.

Set Maximum Temperature and Commissioning Cycle

1. Shower is **OFF**.

Water has **STOPPED** flowing.

Power/Electric is **OFF**.

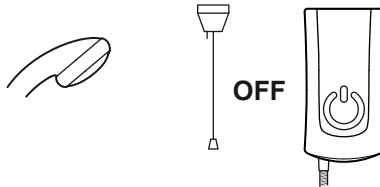

2. Set Maximum Temperature

Turn the dial to the desired position in the table. This will set the maximum temperature for showering.

When showering, the set maximum temperature is reached when the dial is turned to number '9'.

(See also section: "**BEAB Care**".)

Record the Maximum Temperature setting on the BEAB Care In-Service Test Record (separate form supplied) if applicable to the installation.

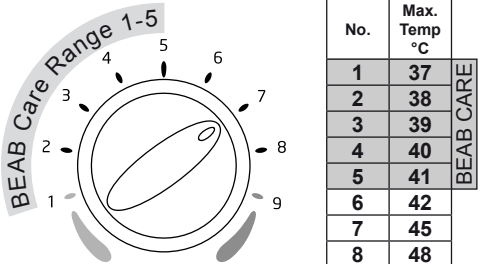



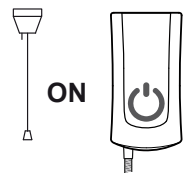

3. Turn Power/Electric **ON**.



Within 30 seconds push and hold **FLOW & START/STOP** together.



4.   1st Beep (LONG) - Release **START/STOP**. 
 2nd Beep (SHORT) - Release **FLOW**. 

5. HIGH FLOW LIGHT FLASHES

This indicates shower is commissioning correctly. Water flows for approximately 1 minute 20 seconds. In some cases the cycle can take up to 3 minutes. Allow shower to stop automatically. **IMPORTANT! DO NOT INTERRUPT THE CYCLE!**



COMMISSIONING FAILURES

(the commissioning cycle was stopped due to an error)

No flashing FLOW LIGHT... solution ...Restart the commissioning cycle.

No water after 5 seconds... solution ...Reprime the shower. (See "Installation".)

WATER SUPPLY or

RESET light is on..... solution ...Reprime the shower. (See "Installation".)

6. Push **START/STOP** to turn shower **ON**.
 Check that maximum temperature is acceptable to the user.

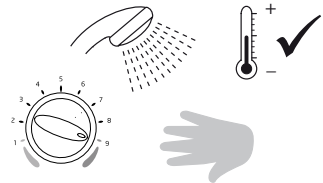

7. Push **START/STOP** to turn shower **OFF**.
 Wait until water has stopped flowing **BEFORE** turning Power/Electric **OFF**.

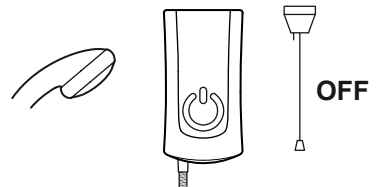

8. Residual water may drain over a few minutes.



BEAB Care

If the shower's maximum temperature is set to 41 °C or cooler, there is a clear triple beep tone and single pulse of the **Start/Stop** light every time the double pole switch is turned on. This is to indicate that the appliance is in a '**BEAB Care**' compliant mode. If recommissioning is required whilst in this mode, wait until 3 beeps have passed before starting the commissioning cycle.

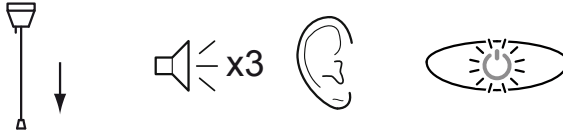

Memory Model

If the maximum temperature is adjusted **after** it has been stored in one or more of the memory buttons (refer to section: '**Operation, Storing the Memory Presets**' in the '**Mira Advance ATL User Guide**'), then the showering temperature cannot exceed the **new maximum setting**.

E.g.

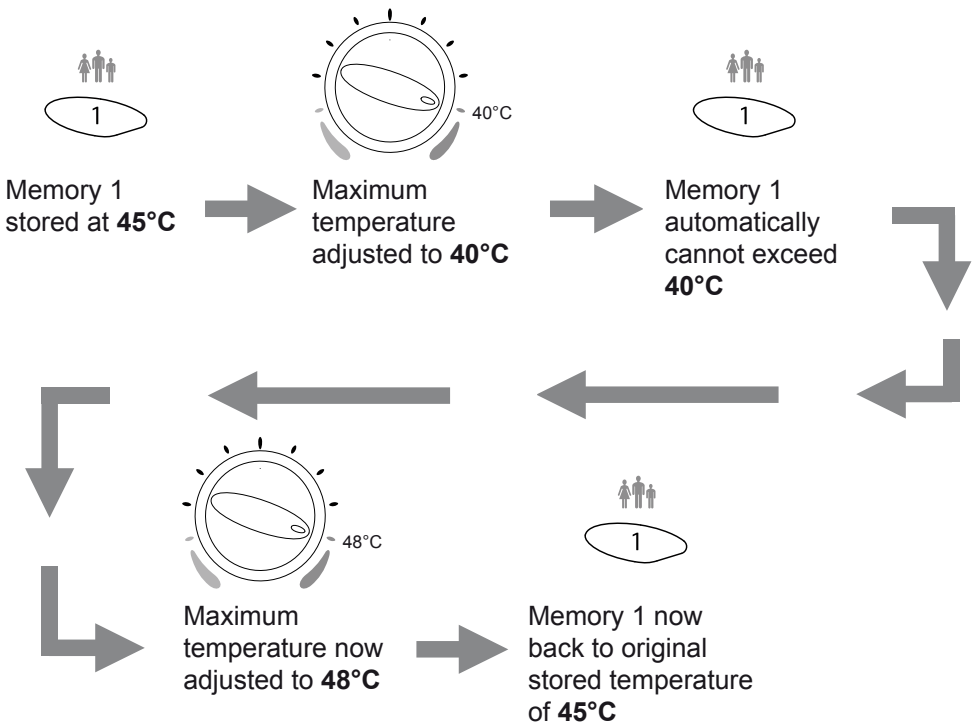

FAULT DIAGNOSIS

1. Installer Troubleshooting Guide

Refer to section: '**Important Safety Information**' first and refer also to '**User Trouble Shooting Guide**'.

The following troubleshooting solutions may require the removal of the cover of the shower. The cover should only be removed by a competent tradesperson and when doing so they should be aware of the following:

- Isolate the electrical and water supplies before initially removing the cover.
- Make sure Ribbon Cable is disconnected when removing the front cover and reconnect when maintenance is complete.
- Mains connections are exposed when the cover is removed.
- Refer to wiring diagram before making any electrical connections.
- Make sure all electrical connections are tight to prevent arcing/overheating.
- Make sure all plumbing connections are watertight.

When following these instructions, it is sometimes necessary to examine the appliance with the electrical and water supplies turned **on**. It is therefore essential that the appropriate safe working practices are followed in accordance with the current Health and Safety Legislation.

If conducting a continuity check using a multimeter, make sure the electrical supply is **ISOLATED**.

2. DIAGNOSTIC PROCEDURE

1. Ensure the shower pullcord / isolator switch is in the **OFF** position, then turn **ON** the pullcord / isolator switch.
2. If the unit 'Beeps' & the Start / Stop button is flashing **WAIT for 20 SECONDS** until the button stops flashing.

NOTE! If the Start / Stop button continues to flash & no beep was heard upon start up, refer to **ERROR CODE 16** on the fault code sheet.

3. Start the shower & observe light fault indication (if any) & refer to Error Code Sheet to determine failure and rectify.

NOTE! If the shower operates normally run the unit for at least 5 minutes at showering temperature & ensure the temperature remains stable.



















4. Turn the shower off at the Start / Stop Button & observe 'phased shutdown'. **DO NOT** isolate the power at the pullcord / isolator switch until the water flow stops.
5. Turn off the power at the pullcord / isolator switch, then turn the power back on and commission the shower.
6. Run the shower for at least 5 minutes.
7. Show the user the correct start / stop procedure and general operation of the shower. Advise user that isolating the shower before the flow has stopped may damage the shower.

For the fault codes 0 to 14 and 18, the reset light will be on or flashing. This will require the shower to be turned off at the pullcord / isolator switch to reset the unit. When the pullcord / isolation switch is turned back on the shower may beep and the Start / Stop button may flash. If this occurs go back to action number 2 and re-follow the Diagnostic Procedure.





Advance Error Codes / Display, Causes and Rectification

No light ○ Flashing light  Solid light ●

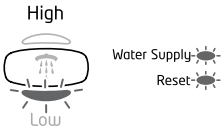
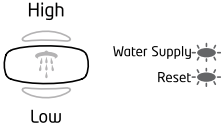
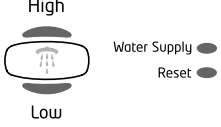
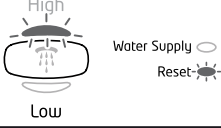
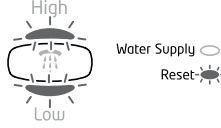
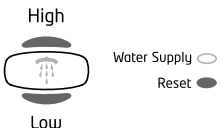
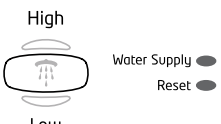
All fault codes will require the shower to be turned off at the pullcord / isolator switch to reset the unit. When the pullcord / isolation switch is turned back on the shower may beep and the Start / Stop button may flash. If this occurs go back to action number 2 and re-follow the Diagnostic Procedure

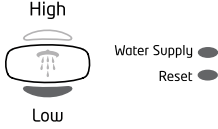
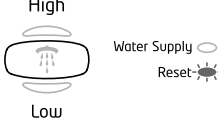
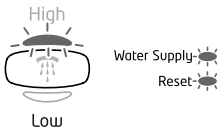
Error Code	Indicator Display	Possible Cause/Rectification
A	Water Supply-  - OR  Reset 	<p>Problem with water supply, unit still operates.</p> <ol style="list-style-type: none"> 1. Check all isolator valves are fully open. 2. Clean / replace filter, refer to section: 'Maintenance'. 3. Blocked Hose / showerhead. 4. Check Inlet Temperature not too high.
0	High  Low Water Supply  Reset 	<p>An unidentified error has occurred.</p> <ol style="list-style-type: none"> 1. Replace Control PCB / Cover.
1	High  Low Water Supply  Reset 	<p>Incoming flow too low for appliance to operate safely.</p> <ol style="list-style-type: none"> 1. Check all plumbing isolator valves to the shower are turned fully on 2. Reset - Commission the shower. 3. Blocked or partially blocked filter, hose or showerhead . 4. A section of the supply pipe may be frozen (thaw). (Advise customer of incorrect installation) 5. Replace Flow Valve. 6. Replace Thermal Switch. 7. Replace Heater Tank.
2	High  Low Water Supply  Reset 	<p>Internal electrical supply problem.</p> <ol style="list-style-type: none"> 1. Replace Relay Board. 2. Replace Control PCB / Cover. 3. Replace Thermal Switch.
3	High  Low Water Supply  Reset 	
4	High  Low Water Supply  Reset- 	<p>Appliance has been incorrectly shut down.</p> <ol style="list-style-type: none"> 1. Replace Relay Board & Control PCB / Cover TOGETHER. <p>Advise the user on correct start/stop procedure and general operation of the shower, refer to User Guide.</p>

<p>5</p>		<p>Incoming water temperature too high.</p> <ol style="list-style-type: none"> 1. Check inlet water temperature is not too high. (E.g. pipework runs alongside hot pipe). 2. Replace Flow Valve. 3. Replace Control PCB / Cover. 4. If the unit is an 'Extra' or 'Flex Extra' model, replace the Drain Pump PCB.
<p>6</p>		<p>Flow Valve Assembly is disconnected or faulty.</p> <ol style="list-style-type: none"> 1. Check all internal cable connections. 2. The shower or a section of the supply pipe may be frozen. 3. Replace Flow Valve. 4. Replace Control PCB / Cover.
<p>7</p>		<p>False flow reading/No shut off failure.</p> <ol style="list-style-type: none"> 1. Isolate power to the unit. Does flow stop? No - Replace flow valve. Yes - Replace relay board.
<p>8</p>		<p>Safety relay failure.</p> <ol style="list-style-type: none"> 1. Check relay contacts. (Debris on contacts or welded closed) 2. Check Ribbon Cable Connection. 3. Replace Relay Board. 4. Replace Control PCB / Cover. 5. Replace Thermal Switch.
<p>9</p>		<p>Internal Electrical Supply problem / Faulty Control PCB or Relay Board. Appliance has been incorrectly shut down.</p> <ol style="list-style-type: none"> 1. Push bleed button to flush the heater tank. 2. Replace Relay Board 3. Replace Control PCB / Cover. <p>Advise the user on correct start/stop procedure and general operation of the shower, refer to User Guide.</p>
<p>10</p>		<p>Outlet Sensor faulty or disconnected from Relay Board or faulty Control PCB.</p> <ol style="list-style-type: none"> 1. Check Outlet Sensor connection to the Relay Board. 2. Check Ribbon Cable Connection. 3. Replace Control PCB / Cover. 4. Replace Relay Board. 5. Replace Heater Tank.
<p>11</p>		<p>Outlet Sensor faulty or disconnected from Relay Board or faulty Control PCB.</p> <ol style="list-style-type: none"> 1. Check Outlet Sensor connection to the Relay Board. 2. Check Ribbon Cable Connection. 3. Replace Control PCB / Cover. 4. Replace Relay Board. 5. Replace Heater Tank.

<p>12</p>		<p>Unsafe hot water detected.</p> <ol style="list-style-type: none"> Unit incorrectly shut down causing hot water to trip the max temp limit, this would be following ERROR 17. Hot water in the heater tank, bleed via the blue button. Check Outlet Sensor connection to the Relay Board. Check Ribbon Cable Connection. Replace Control PCB / Cover. Replace Relay Board. Replace Heater Tank. <p>Advise the user on correct start/stop procedure and general operation of the shower, refer to User Guide.</p>
<p>13</p>		<p>This failure only occurs during commissioning.</p> <ol style="list-style-type: none"> Check operation of relays / replace Relay Board if necessary. Replace Flow valve. Replace Control PCB / Cover. Replace Heater Tank.
<p>14</p>		<p>Error lights when unit is re-started.</p> <p>This error occurs when the shower has been incorrectly shutdown and the unit senses over temperature (refer to ERROR 17).</p> <p>Advise the user on correct start/stop procedure and general operation of the shower, refer to User Guide.</p>
<p>15</p>		<p>Unit fails to start.</p> <ol style="list-style-type: none"> Replace Relay Board and Control PCB / Cover TOGETHER.
<p>16</p>		<p>High & Low or Start / Stop lights pulsing rapidly.</p> <ol style="list-style-type: none"> Associated Button stuck / Replace Control PCB / Cover.
<p>17</p>		<p>Start / Stop Lights Pulsing Slowly</p> <ol style="list-style-type: none"> If a 2 second beep and the Start / Stop button is pulsing SLOWLY = Appliance has been incorrectly shut down. Refer to Diagnostic Procedure action number 2. <p>Product can still be operated safely. Flashing light will stop after 20 seconds.</p> <p>Advise the user on correct start/stop procedure and general operation of the shower, refer to User Guide.</p>

For drain pump only: Advance 'Extra' models

18

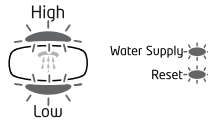

Shower stops
 Drain Pump stops
 1 beep and all lights
 flash 6 times

Drain Pump not communicating with Shower.

1. Check power to Drain Pump.
2. Check connection between Drain Pump and Shower. If wireless, reregister the signal and retest using the procedure in this guide, see '**Drain Pump Registration**'.
3. Wireless Channels.

It may be necessary to alter the shower's wireless frequency to avoid radio interference which can prevent the Drain Pump from operating correctly.

There are 3 channels which can be selected individually using 1-3 on the temperature control.

Default frequency is position 1

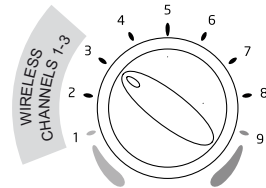

- a. Turn shower off and isolate electric/power.
- b. Choose channel number 2 or 3 with the temperature control.
- c. Repeat steps 2-4 of the Drain Pump Registration instructions found in this guide.

If more than one shower and pump combination are operating in close proximity to each other, make sure that each shower is set to a different channel.

4. Should all attempts fail to operate the shower and pump wirelessly due to interference or poor signal strength. The shower can be hardwired using, Spare - Drain Pump PCB kit 1643.112.

Unattended Operation

The appliance has a built in 'Shower Stop' timer to protect from accidental unattended operation. This feature automatically switches the shower off after 40 minutes of continuous use. Normal operation is restored by re-selecting the **Start/Stop** button.

BEAB CARE IN-SERVICE TESTS

The following procedure applies to products operated and maintained within the BEAB Care requirements. This procedure should be conducted by designated, qualified and competent personnel only.

To maintain the validity of the BEAB Care mark, regular inspections of the installation and appliance should be carried out. The purpose of the in-service tests is to monitor and record the performance of the shower. Any deterioration in performance can indicate the need for maintenance work on the appliance and/or the water supplies.

Frequency of Inspections

Upon the initial installation of the shower and after any major repair work (e.g. Renewing the Flow Valve or Heater Tank etc...), the in-service tests must be performed and the results recorded on the BEAB Care In-Service Test Record to provide a reference point for future inspections (The BEAB Care In-Service Test Record is on page 39).

The shower should be inspected again within 6 to 8 weeks after installation or any major repair.

BEAB Care In-Service Test Record									mira <small>SHOWERS</small>
Installation Address: _____				Maximum Temperature Setting: _____ <small>(maximum at 10 bar pressure)</small>					
Location of Shower: _____									Date: _____
Installed by: _____									
Date / Signature	Not Operating			Normal Operation			Restricted Supply		Equipment Details <small>(make, model, serial number, cartridge size etc...)</small>
	Terminal Block Voltage (V)	Inlet Water Temp. (°C)	Inlet Filter Cleaned	Terminal Block Voltage (V)	Outlet Water Temp. (°C)	Flow Rate (litres)	Outlet Water Temp. (°C)	Flow Rate (litres)	

Please record all test results on this form, including details of all measurement equipment used. This form is available to download at www.mirashowers.co.uk

If there is no significant change in the outlet water temperature greater than ± 1 °C between the two inspections, the in-service test frequency may be reduced but must not exceed 12 months between any two inspections.

Equipment Required

The following equipment or suitable equivalent will be required in order for the tests to be performed:

- Digital Multimeter (crocodile clip probes are recommended)
- 100 mm diameter plastic funnel
- Digital liquid thermometer accurate to 0.1 °C
- 2 - 22 l/min flow measure cup
- Cup or container suitable for catching water

1. Run the shower with the temperature control set to full cold and the flow set to high for 2 - 3 minutes and then stop the shower. Isolate the electrical and water supplies.
2. For falling supplies, remove the inlet filter (see Maintenance) and use a cup or suitable container to catch a small quantity of water that will flow from the inlet connector as the filter is removed. Measure the temperature of the water that is collected.
3. For rising supplies, remove the inlet filter (see Maintenance) and use a suitable probe to measure the temperature of the water inside the inlet connector.
4. The temperature of the water must be within the range of 5 - 20 °C, record the temperature on the test record.
5. Clean and if necessary renew the inlet filter. Refit the inlet filter (See Maintenance.)
6. Switch on the electrical supply to the shower and measure the voltage at the terminal block. The voltage must be in the range 230V \pm 10%. Isolate the electrical supply and record the voltage on the test record.
7. Turn on the water supply and check for leaks. Reprime the shower (see Installation - Priming the Shower). Remove the showerhead from the hose. Position the end of the hose to allow water to drain safely when the shower is running, if necessary secure the hose in this position.
8. **WARNING, LIVE ELECTRICAL WIRES ARE EXPOSED WHILE SHOWER IS RUNNING!**
Connect the ribbon cable to the cover. Switch on the electrical supply to the shower and run the shower with the temperature control turned to full hot and the flow set to high. Measure the supply voltage at the terminal block (this may require a second person to assist). Stop the shower, isolate the electrical supply and record the voltage on the test record.
(If the ribbon cable becomes disconnected the shower will assume a failure has occurred and stop automatically. Isolate the electrical supply, reconnect the ribbon cable and restart this section of the test.)
9. Refit the cover and screws. Refit the showerhead to the hose and reattach to the slidebar or showerhead holder. Switch on the electrical supply to the shower.
10. Run the shower with the temperature set to full hot and the flow set to high. Using the plastic funnel, catch all the water flowing from the showerhead and measure the temperature of the water flowing from the funnel. The temperature must be no more than 2 °C above the maximum temperature setting. Record the temperature on the test record. Using the flow measure cup, measure the rate of water flow from the funnel and record the result on the test record.
11. Run the shower set to full hot and the flow set to high. Slowly restrict the water supply to the shower by closing the isolating valve gradually until the shower shuts down due to the reduced flow. Switch off the electrical supply and open the isolating valve by a small amount. Remove the cover and hold down the air bleed button (see Installation - Priming the Shower) to expel all hot water from the tank.
12. Refit the cover and switch on the electrical supply to the shower. Run the shower for 2 - 3 minutes at full hot and high flow to make sure that it will operate continuously, then measure the water temperature and rate of flow as described in test 10 and record the results on the test record. The temperature must be no more than 2 °C above the maximum temperature setting. If the shower will not run continuously for at least 2 minutes and shuts down due to a temperature or flow error, then reset the shower and reprime to again expel all hot water. Open the isolating valve by a further small amount and attempt a retest. **Always have the cover fitted when running the shower during this test.** When a successful test has been performed and recorded, open the isolating valve fully and set the temperature to mid blend. Stop the shower and isolate the electrical supply. Secure the cover with the screws.

If the normal operation outlet water temperature has changed by more than 1 °C since the previous inspection, or if either of the outlet water temperature measurements are more than 2 °C above the maximum temperature setting, the shower showerhead, hose and inlet filter should be checked for blockages and cleaned and descaled or if required renewed. Checks should be performed to confirm that any check valves or other backflow prevention devices are working correctly and that any isolating valves in the supply pipework are fully open. The shower should be recommissioned at the relevant maximum temperature setting and retested. If the temperatures are not able to be brought in line with these requirements, **the shower must not be used.**

MAINTENANCE

Tradesperson Maintenance - Inlet Filter Cleaning/Replacing

Read the section 'Important Safety Information' first.

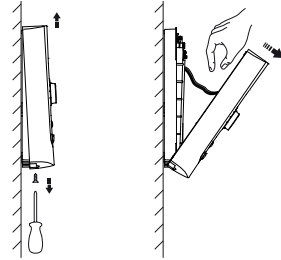
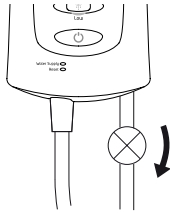

1. Electrical and water supplies to appliance are turned off.
2. Remove cover screw, cover and splash guard. Disconnect ribbon cable from cover

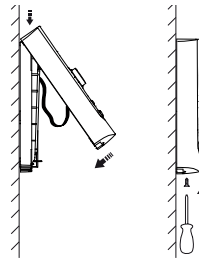
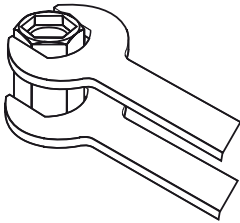

3. Hold a spanner or other suitable grips across flats of the metal connector. Unscrew filter using another spanner as shown. Clean or replace filter as necessary. Refit filter making sure it is screwed fully home. **Do not overtighten.**
4. Make sure all plumbing connections are sealed before restoring water supply. **Re-prime appliance** (refer to 'Installation') before restoring electricity supply. Refit splash guard, ribbon cable and cover.

SPARE PARTS AND ACCESSORIES

416.38	Clamp Bracket
1643.100	Thermal Switch.
1643.101	Tank Assembly 9 kW/230 V 9.8 kW/240 V (earth wire not included).
1643.102	Tank Assembly 8.2 kW/230 V 9 kW/240 V (earth wire not included).
1643.103	Terminal Block/Earth Wire/Neutral Wire.
1643.104	Relay Board (including screws).
1643.105	Top and Bottom Cover Inserts (white).
1643.112	Drain Pump PCB - Extra models only.
1643.113	Component Pack (components identified 'B').
1643.114	Splash Guard.
1643.144	Top and Bottom Cover Inserts (grey).
1643.148	Seal Pack (components identified 'A').
1643.149	Flow Valve Assembly (components identified 'C').
1643.251	Cover and PCB Assembly (Standard)
1643.252	Cover and PCB Assembly (Flex)
1643.255	Cover and PCB Assembly (Memory)
1643.262	Cover and PCB Assembly (Flex Extra Wireless)
1829.062	Filter Assembly
1829.063	Inlet Connector.

Warning! If the wiring layout is changed or amended, the product functionality and safety may be affected.

Warning! In the interests of safety, spares requiring exposure to mains voltage should only be fitted by competent persons.

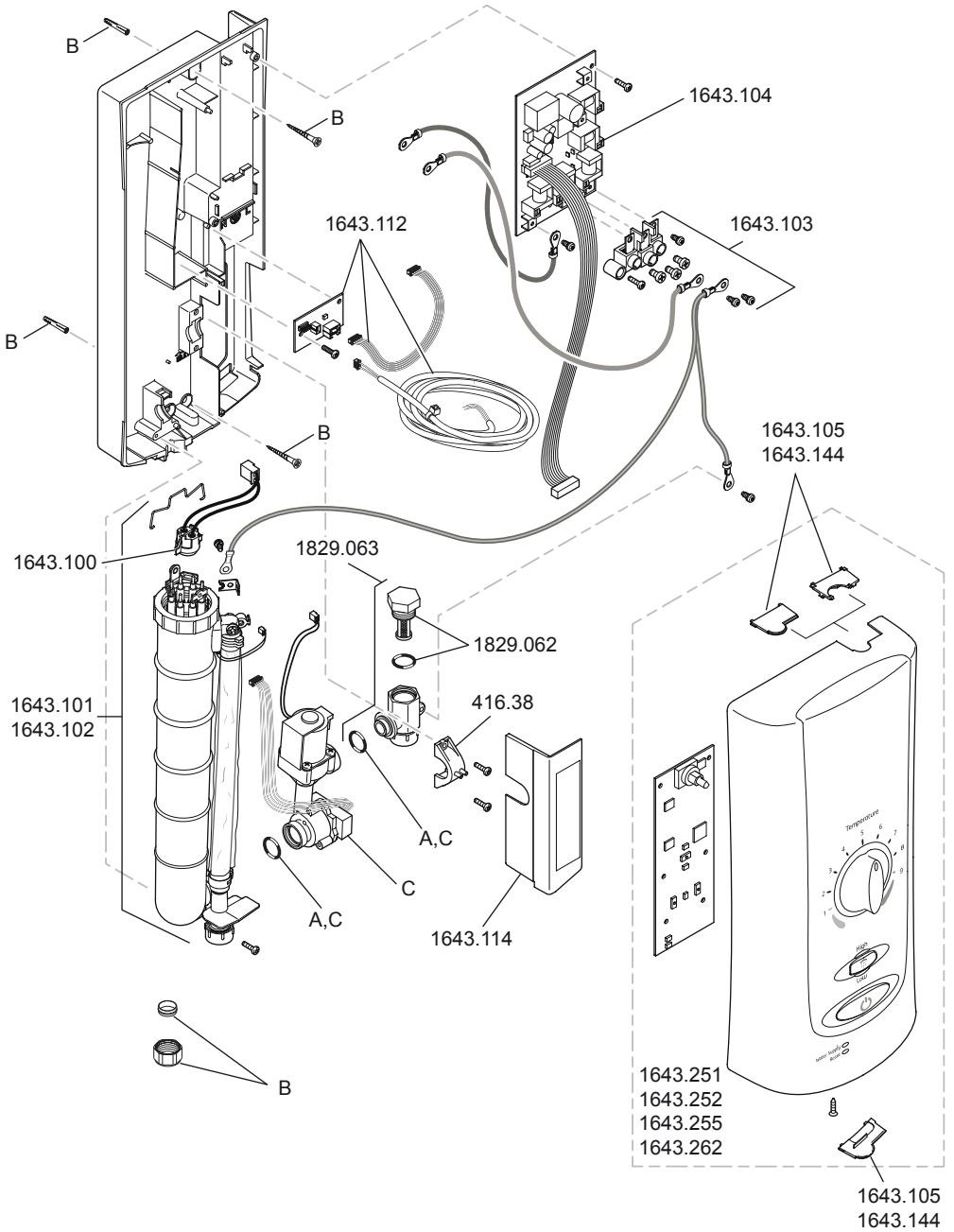

WIRING DIAGRAM

(Fitted to Standard Extra and Flex Extra models only.)

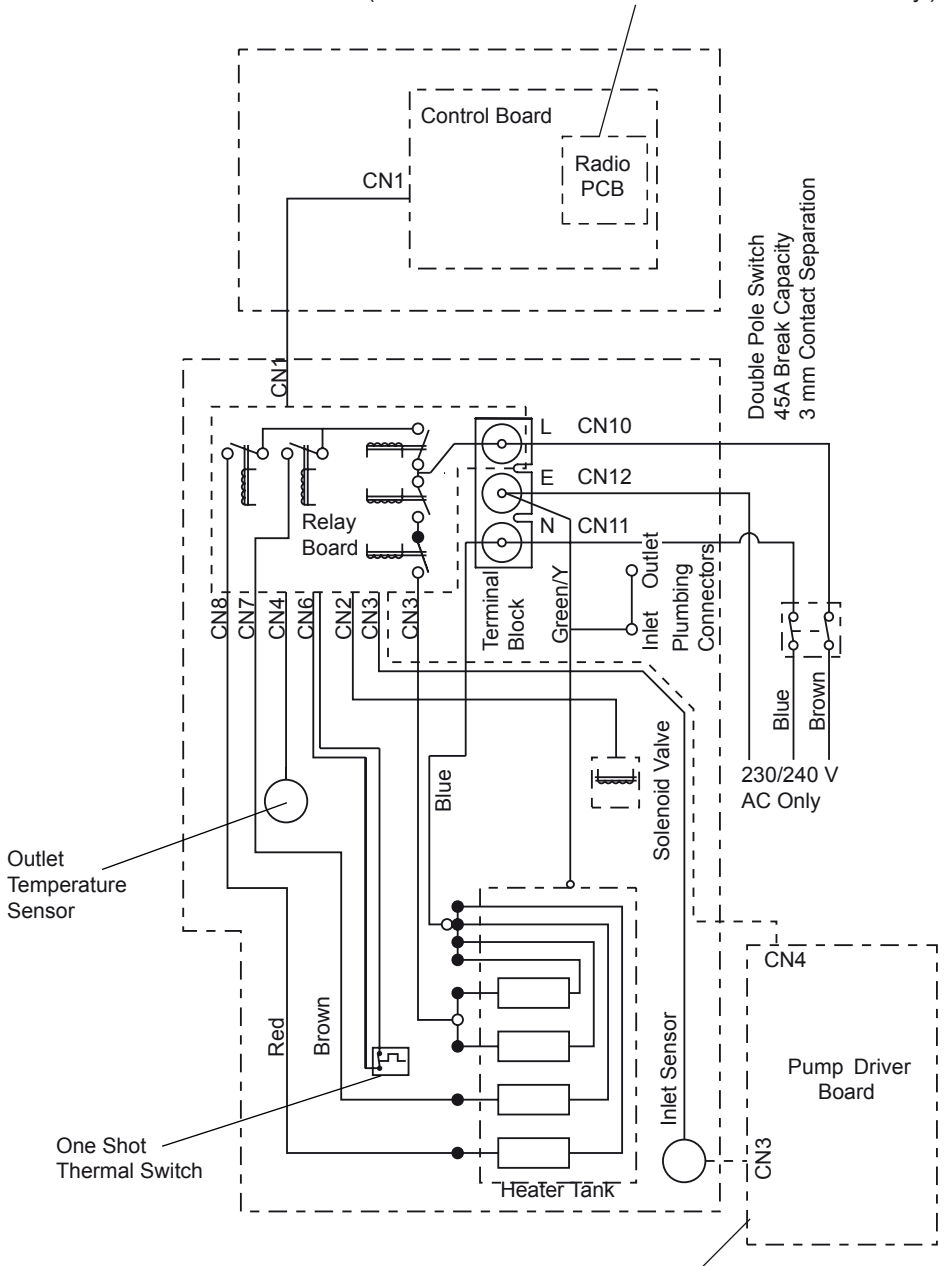

(Fitted to Standard Extra and Flex Extra models only.)

BEAB Care In-Service Test Record



Installation Address: _____

Location of Shower: _____

Maximum Temperature Setting:
(maximum of 41 °C for showering)

Installed by: _____ Date: _____

Date / Signature	Not Operating			Normal Operation			Restricted Supply		Equipment Details (make, model, serial number, calibration date etc...)
	Terminal Block Voltage (V)	Inlet Water Temp. (°C)	Inlet Filter Cleaned	Terminal Block Voltage (V)	Outlet Water Temp. (°C)	Flow Rate (l/min)	Outlet Water Temp. (°C)	Flow Rate (l/min)	

Please record all test results on this form, including details of all measurement equipment used. This form is available to download at www.mirashowers.co.uk.

CUSTOMER SERVICE

Guarantee

Your product has the benefit of our manufacturer's guarantee which starts from the date of purchase. This guarantee only applies in the United Kingdom and Republic of Ireland. To activate this guarantee, please return your completed registration card, visit our website or free phone **0800 5978551** within 30 days of purchase (UK only).

Within the guarantee period we will resolve defects in materials or workmanship, free of charge, by repairing or replacing parts or product as we may choose.

This guarantee is in addition to your statutory rights and is subject to the following conditions:

- The guarantee applies solely to the original installation under normal use and to the original purchaser only. The product must be installed and maintained in accordance with the instructions given in this guide.
 - Servicing must only be undertaken by us or our appointed representative.
- Note!** If a service visit is required the product must be fully installed and connected to services.
- Repair under this guarantee does not extend the original expiry date. The guarantee on any replacement parts or product ends at the original expiry date.
 - For shower fittings or consumable items we reserve the right to supply replacement parts only.

The guarantee does not cover:

- Call out charges for non product faults (such as damage or performance issues arising from incorrect installation, improper use, inappropriate cleaning, lack of maintenance, build up of limescale, frost damage, chemical attack, corrosion, system debris or blocked filters) or where no fault has been found with the product.
- Water or electrical supply, wast and isolation issues.
- Compensation for loss of use of the product or consequential loss or indirect loss of any kind.
- Damage or defects caused if the product is repaired or modified by persons not authorised by us or our appointed representative.
- Routine maintenance or replacement parts to comply with the requirements of the TMV2 or TMV3 healthcare schemes.
- Accidental or wilful damage.
- Products purchased ex-showroom display.

What to do if something goes wrong

If your product does not work correctly refer to this guide for fault diagnosis and check that it is installed and commissioned in accordance with our instructions. If this does not resolve the issue, contact us for help and advice.



Helpdesk Service

Contact our Customer Service Team for product advice, to purchase spare parts or accessories or to request a service visit. You can contact us via phone or e-mail - contact details below. Please provide your model name, power rating (if applicable) and date of purchase.



Mira Showers Website (www.mirashowers.co.uk)

Visit our website to register your guarantee, download user guides, diagnose faults, purchase our full range of accessories and popular spares, or request a service visit.



Spares and Accessories

We hold the largest stocks of genuine Mira spares and accessories. Contact us for a price or visit our website to purchase items from our accessory range and popular spares. (Only available in the United Kingdom.)



Service/Repairs

No one knows our products better than our nationwide team of Service Technicians. We carry out service or repair work to your product both during and after the guarantee period. (Only available in the United Kingdom and Republic of Ireland.) Ask about our fixed price service repairs.

To Contact Us: UK



0844 571 5000

Please note: Calls cost 7p per minute plus your phone company's access charge.



01242 282595



Email - Visit

www.mirashowers.co.uk/contactus



By Post:

**Mira Customer Services Dept, Cromwell Road,
Cheltenham, Gloucestershire, GL52 5EP**

To Contact Us: Eire Only



01 531 9337



Email -

CustomerServiceEire@mirashowers.com

*Mira is a registered trade mark of
Kohler Mira Limited.*

*The company reserves the right to alter
product specifications without notice.*



FM 14648

mira
SHOWERS