

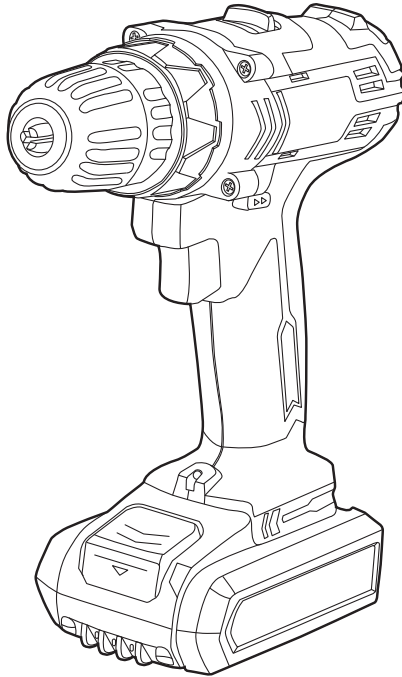

18V Cordless Drill



MSDD18-Li-2

EAN: 3663602798675

WARNING: Read the instructions before using the product!



Let's get started...

These instructions are for your safety. Please read through them thoroughly before use and retain them for future reference.



Getting **Started...** 02

Safety information	03
Symbols	12
Your product	14
Technical specifications	15
Before you start	16



In more **detail...** 21

Intended use	21
Product functions	21
General operation	24
Care and maintenance	25
Troubleshooting	27
Recycling and disposal	28
Guarantee	28
EC declaration of conformity	29

Safety warnings

General power tool safety warnings



WARNING! Read all safety warnings, instructions, illustrations and specifications provided with this power tool. *Failure to follow all instructions listed below may result in electric shock, fire and/or serious injury. Save all warnings and instructions for future reference. The term “power tool” in the warnings refers to your mains-operated (corded) power tool or battery-operated (cordless) power tool.*

Work area safety

- > **Keep work area clean and well lit.** *Cluttered or dark areas invite accidents.*
- > **Do not operate power tools in explosive atmospheres, such as in the presence of flammable liquids, gases or dust.** *Power tools create sparks which may ignite the dust or fumes.*
- > **Keep children and bystanders away while operating a power tool.** *Distractions can cause you to lose control.*

Electrical safety

- > **Power tool plugs must match the outlet. Never modify the plug in any way. Do not use any adapter plugs with earthed (grounded) power tools.** *Unmodified plugs and matching outlets will reduce risk of electric shock.*
- > **Avoid body contact with earthed or grounded surfaces, such as pipes, radiators, ranges and refrigerators.** *There is an increased risk of electric shock if your body is earthed or grounded.*

- > **Do not expose power tools to rain or wet conditions.** *Water entering a power tool will increase the risk of electric shock.*
- > **Do not abuse the cord. Never use the cord for carrying, pulling or unplugging the power tool. Keep cord away from heat, oil, sharp edges or moving parts.** *Damaged or entangled cords increase the risk of electric shock.*
- > **When operating a power tool outdoors, use an extension cord suitable for outdoor use.** *Use of a cord suitable for outdoor use reduces the risk of electric shock.*
- > **If operating a power tool in a damp location is unavoidable, use a residual current device (RCD) protected supply.** *Use of an RCD reduces the risk of electric shock.*

Personal safety

- > **Stay alert, watch what you are doing and use common sense when operating a power tool. Do not use a power tool while you are tired or under the influence of drugs, alcohol or medication.** *A moment of inattention while operating power tools may result in serious personal injury.*
- > **Use personal protective equipment. Always wear eye protection.** *Protective equipment such as a dust mask, non-skid safety shoes, hard hat, or hearing protection used for appropriate conditions will reduce personal injuries.*
- > **Prevent unintentional starting. Ensure the switch is in the off-position before connecting to power source and/or battery pack, picking up or carrying the tool.** *Carrying power tools with your finger on the switch or energising power tools that have the switch on invites accidents.*
- > **Remove any adjusting key or wrench before turning the power tool on.** *A wrench or a key left attached to a rotating part of the power tool may result in personal injury.*

- > **Do not overreach. Keep proper footing and balance at all times.** *This enables better control of the power tool in unexpected situations.*
- > **Dress properly. Do not wear loose clothing or jewellery. Keep your hair and clothing away from moving parts.** *Loose clothes, jewellery or long hair can be caught in moving parts.*
- > **If devices are provided for the connection of dust extraction and collection facilities, ensure these are connected and properly used.** *Use of dust collection can reduce dust-related hazards.*
- > **Do not let familiarity gained from frequent use of tools allow you to become complacent and ignore tool safety principles.** *A careless action can cause severe injury within a fraction of a second.*

Power tool use and care

- > **Do not force the power tool. Use the correct power tool for your application.** *The correct power tool will do the job better and safer at the rate for which it was designed.*
- > **Do not use the power tool if the switch does not turn it on and off.** *Any power tool that cannot be controlled with the switch is dangerous and must be repaired.*
- > **Disconnect the plug from the power source and/or remove the battery pack, if detachable, from the power tool before making any adjustments, changing accessories, or storing power tools.** *Such preventive safety measures reduce the risk of starting the power tool accidentally.*
- > **Store idle power tools out of the reach of children and do not allow persons unfamiliar with the power tool or these instructions to operate the power tool.** *Power tools are dangerous in the hands of untrained users.*

- > **Maintain power tools and accessories.** Check for misalignment or binding of moving parts, breakage of parts and any other condition that may affect the power tool's operation. If damaged, have the power tool repaired before use. *Many accidents are caused by poorly maintained power tools.*
- > **Keep cutting tools sharp and clean.** *Properly maintained cutting tools with sharp cutting edges are less likely to bind and are easier to control.*
- > **Use the power tool, accessories and tool bits etc. in accordance with these instructions, taking into account the working conditions and the work to be performed.** *Use of the power tool for operations different from those intended could result in a hazardous situation.*
- > **Keep handles and grasping surfaces dry, clean and free from oil and grease.** *Slippery handles and grasping surfaces do not allow for safe handling and control of the tool in unexpected situations.*

Battery tool use and care

- > **Recharge only with the charger specified by the manufacturer.** *A charger that is suitable for one type of battery pack may create a risk of fire when used with another battery pack.*
- > **Use power tools only with specifically designated battery packs.** *Use of any other battery packs may create a risk of injury and fire.*
- > **When battery pack is not in use, keep it away from other metal objects, like paper clips, coins, keys, nails, screws or other small metal objects that can make a connection from one terminal to another.** *Shorting the battery terminals together may cause burns or a fire.*

- > **Under abusive conditions, liquid may be ejected from the battery; avoid contact. If contact accidentally occurs, flush with water. If liquid contacts eyes, additionally seek medical help.** *Liquid ejected from the battery may cause irritation or burns.*
- > **Do not use a battery pack or tool that is damaged or modified.** *Damaged or modified batteries may exhibit unpredictable behaviour resulting in fire, explosion or risk of injury.*
- > **Do not expose a battery pack or tool to fire or excessive temperature.** *Exposure to fire or temperature above 130 °C may cause explosion.*
- > **Follow all charging instructions and do not charge the battery pack or tool outside the temperature range specified in the instructions.** *Charging improperly or at temperatures outside the specified range may damage the battery and increase the risk of fire.*

Service

- > **Have your power tools serviced by a qualified repair person using only identical replacement parts.** *This will ensure that safety of the power tool is maintained.*
- > **Never service damaged battery packs.** *Service of battery packs should only be performed by the manufacturer or authorized service providers.*

Drill safety warnings

- > **Wear ear protectors when impact drilling.** *Exposure to noise can cause hearing loss.*
- > **Use auxiliary handle(s), if supplied with the tool.** *Loss of control can cause personal injury.*
- > **Hold the power tool by insulated gripping surfaces, when performing an operation where the cutting accessory or**

fasteners may contact hidden wiring. *Cutting accessory contacting a “live” wire may make exposed metal parts of the power tool “live” and could give the operator an electric shock.*

Additional safety warnings for charger

- > This charger can be used by children aged from 8 years and above and persons with reduced physical, sensory or mental capabilities or lack of experience and knowledge if they have been given supervision or instruction concerning use of the charger in a safe way and understand the hazards involved.
- > Children shall not play with the charger. Cleaning and user maintenance shall not be made by children without supervision.
- > Disconnect the charger from the power supply and allow it to cool down before cleaning, maintenance, storage and transportation.
- > Before using the charger, read all the instructions and cautionary markings on the charger and battery pack.
- > The charger and battery pack supplied with it are specifically designed to work together. Only use the charger with the battery pack specified for this product.
- > Charge the battery pack indoors only as the charger is designed for indoor use only.
- > Do not charge non-rechargeable batteries.
- > Protect the charger against moisture and wet conditions. There is a danger of electric shock.
- > Do not place any object on top of the charger as it could cause overheating. Do not place the charger near any heat source.
- > Do not use an extension cord unless it is absolutely necessary. The use of an improper extension cord could cause the risk of fire, electric shock or electrocution.

- > Do not use the charger if it has been subjected to a heavy knock, dropped or otherwise damaged in any way. Have the charger checked and repaired by an authorised service centre.

Additional safety warnings for battery packs

- > Do not attempt to charge the battery pack with any other charger than the one supplied. The charger and battery pack supplied with it are specifically designed to work together.
- > Charge and store the battery pack in an ambient temperature of 18 - 24°C (65 - 75°F) to ensure the longest battery life and best performance. Do not charge or store the battery pack in temperatures below 0°C (32°F) and above 45°C (113°F).
- > Never attempt to open the battery pack for any reason. If the plastic housing of the battery pack breaks open or cracks, immediately discontinue its use and do not recharge it.
- > Do not store or carry a spare battery pack in a pocket or toolbox or any other place where it may come into contact with metal objects. The battery pack may be short-circuited causing damage to the battery pack, burns or a fire.
- > Do not pierce the battery pack with nails, strike the battery pack with a hammer, step on the battery or otherwise subject it to strong impacts or shocks.
- > Protect the battery pack against heat. Do not place the battery pack in direct sunlight or use or store the battery pack inside cars in hot weather. Doing so may cause the battery pack to generate heat, explode or ignite.
- > Never try to charge a battery pack that is cracked or damaged in any other way. There is a danger of electric shock or electrocution.

The following information applies to professional users only but is good practice for all users:

ADDITIONAL SAFETY WARNING FOR CONSTRUCTION DUST

The updated Control of Substances Hazardous to Health Regulations 1st October 2012 now also targets to reduce the risks associated with silica, wood and gypsum dusts.

Construction workers are one of the at-risk groups within this because of the dust that they breathe: silica dust is not just a nuisance, it is a real risk to your lungs!

Silica is a natural mineral present in large amounts in things like sand, sandstone and granite. It is also commonly found in many construction materials such as concrete and mortar. The silica is broken into very fine dust (also known as Respirable Crystalline Silica or RCS) during many common tasks such as cutting, drilling and grinding. Breathing in very fine particles of crystalline silica can lead to the development of:

Lung cancer
Silicosis
Chronic Obstructive Pulmonary Disorder/
Chronic obstructive pulmonary disease (COPD)
And breathing in fine particles of wood dust can lead to the development of Asthma. The risk of lung disease is linked to people who regularly breathe construction dust over a period of time, not on the odd occasion.

To protect the lung, the COSHH Regulations sets a limit on the amount of these dusts that you can breathe (called a Workplace Exposure Limit or WEL) when averaged over a normal working day. These limits are not a large amount of dust: when compared to a penny it is tiny – like a small pinch of salt:

This limit is the legal maximum, the most you can breathe after the right controls have been used.

How to reduce the amount of dust?

1. Reduce the amount of cutting by using the best sizes of building products.
2. Use a less powerful tool e.g. a block cutter instead of angle grinder.
3. Using a different method of work altogether – e.g. using a nail gun to direct fasten cable trays instead of drilling holes first.

Please always work with approved safety equipment, such as those dust masks that specially designed to filter out microscopic particles and use the dust extraction facility at all time.

For more information please see the HSE website:

<http://www.hse.gov.uk/construction> or <http://www.hse.gov.uk/pubns/cis69.pdf>

Warning: Some dust particles created by power sanding, sawing, grinding, drill and other construction jobs contain chemicals known to cause cancer, birth defects or other reproductive harm. Some examples of these chemicals are:

- > Lead from lead-based paints.
 - > Crystalline silica from bricks and cement and other masonry products.
 - > Arsenic and chromium from chemically treated timber.
- Your risk from these exposures varies, depending upon how often you do this type of work. To reduce your exposure to these chemicals:
- > Work in a well-ventilated area.
 - > Work with approved safety equipment, such as those dust masks that are specially designed to filter microscopic particles.

VIBRATION

The European Physical Agents (Vibration) Directive has been brought in to help reduce hand arm vibration syndrome injuries to power tool users. The directive requires power tool manufacturers and suppliers to provide indicative vibration test results to enable users to make informed decisions as to the period of time a power tool can be used safely on a daily basis and the choice of tool.

SEE TECHNICAL SPECIFICATIONS IN THE INSTRUCTION MANUAL FOR THE VIBRATION LEVELS OF YOUR TOOL.

The declared vibration emission value should be used as a minimum level and should be used with the current guidance on vibration.

Calculating the actual period of use can be difficult and the HSE website has further information.

The declared vibration emission has been measured in accordance with a standardised test stated above and may be used to compare one tool with another tool.

The declared vibration emission value may also be used in a preliminary assessment of exposure.

Warning: The vibration emission value during actual use of the power tool can differ from the declared value depending on the ways in which the tool is used dependant on the following examples and other variations on how the tool is used:

How the tool is used and the materials being cut or drilled.

The tool being in good condition and well maintained.

The use of the correct accessory for the tool and ensuring it is sharp and in good condition.

The tightness of the grip on the handles.

And the tool is being used as intended by its design and these instructions.

While working with this power tool, hand/arm vibrations occur. Adopt the correct working practices in order to reduce the exposure to vibration. This tool may cause hand-arm vibration syndrome if its use is not adequately managed.

Warning: Identify safety measures to protect the operator that are based on an estimation of exposure in the actual conditions of use (taking account of all parts of the operating cycle such as the times when the tool is switched off and when it is running idle in addition to the trigger time).

Emergency

Familiarise yourself with the use of this product by means of this instruction manual. Memorise the safety directions and follow them to the letter. This will help to prevent risks and hazards.

- > **Always be alert when using this product, so that you can recognise and handle risks early.** Fast intervention can prevent serious injury and damage to property.
- > **Switch off and disconnect from the power supply if there are malfunctions.** Have the product checked by a qualified professional and repaired, if necessary, before you operate it again.













Residual risks

Even if you are operating this product in accordance with all the safety requirements, potential risks of injury and damage remain. The following dangers can arise in connection with the structure and design of this product:

- > Health defects resulting from vibration emission if the product is being used over long periods of time or not adequately managed and properly maintained.
- > Injuries and damage to property due to broken cutting attachments or the sudden impact of hidden objects during use.
- > Danger of injury and property damage caused by flying objects.

Symbols

On the product, the rating label and within these instructions you will find among others the following symbols and abbreviations. Familiarise yourself with them to reduce hazards like personal injuries and damage to property.

V~	Volt, (alternating voltage)	°C	Degree Celsius
V 	Volt, (direct current voltage)	Nm	Newton meter
Hz	Hertz	/min or min ⁻¹	Per minute
W	Watt	mm	Milimeter
A	Ampere	kg	Kilogram
mA	Milliampere	dB(A)	Decibel (A-rated)
mAh	Milliampere-hour	m/s ²	Meter per second squared
	Lock / to tighten or secure.		Wear hearing protection.
	Unlock / to loosen.		Wear eye protection.
	Note/Remark		Wear protective gloves.
	Caution/Warning.		Wear protective, slip-resistant footwear.
 	Read the instruction manual.		
yyWxx	Manufacturing date code; year of manufacturing (20yy) and week of manufacturing (Wxx).		
	Switch the product off and remove battery pack before assembly, cleaning, adjustments, maintenance, storage and transportation.		
	This is a product of class II. This means it is equipped with an insulation reinforced or double insulation.		



The product complies with the applicable European directives and an evaluation method of conformity for these directives was done.



WEEE symbol. Waste electrical products should not be disposed of with household waste. Please recycle where facilities exist. Check with your Local Authority or local store for recycling advice.



Crossed out dust bin. Batteries and battery packs should not be disposed of with household waste. Please recycle where facilities exist. Check with your Local Authority or local store for recycling advice.



Indoor use only.



Do not dispose of battery packs in rivers or immerse in water.



Do not dispose of battery packs in fire. They will explode and cause injury.



Do not expose battery packs to heat in excess of 45°C. Do not charge or store the battery pack in temperatures below 0°C (32°F) and above 45°C (113°F).



Approx. 1h charging time.

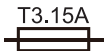

Time lag fuse with rated current of 3.15A

Your product

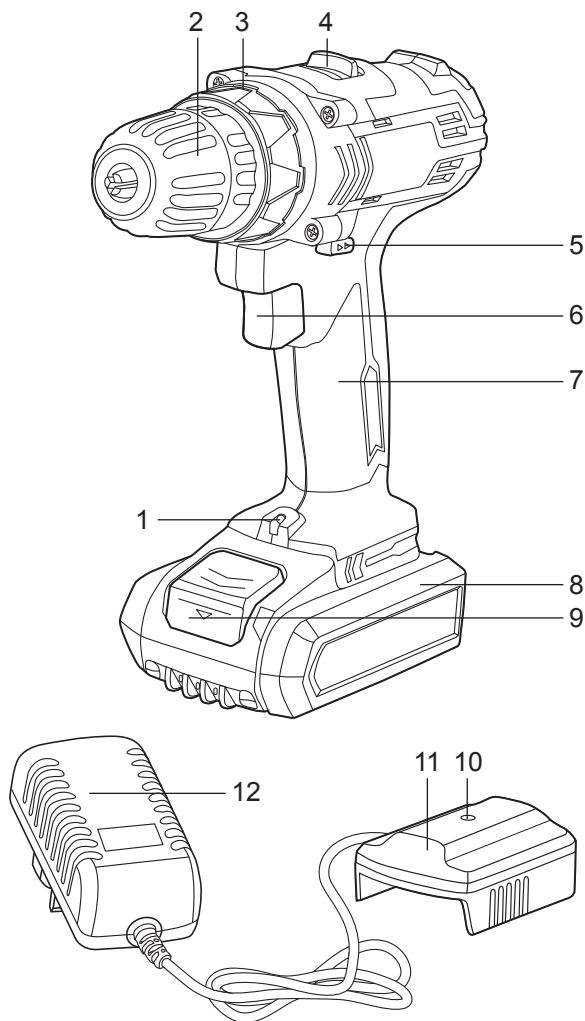

- | | |
|--|---|
| 1. Work light | 8. Battery pack |
| 2. Keyless chuck | 9. Release button |
| 3. Torque adjustment ring | 10. Power / charging status indicator light |
| 4. Two-speed gear control | 11. Charging base |
| 5. Forward/Reverse rotation control switch | 12. Charger |
| 6. ON/OFF switch with variable speed | |
| 7. Handle | |

Technical specifications

Drill	
> Rated voltage	: 18 V d.c.
> Rated no load speed n_0	: 0-400/0-1450/min
> Max. torque	: 30Nm
> Chuck capacity	: \varnothing 10mm
> Drilling capacity	: wood \varnothing 25mm metal \varnothing 10mm
> Weight	: approx. 1.4 kg
Battery pack	
> Model no.	: MBAT18-Li
> Type	: Li-Ion
> Capacity	: 1.5 Ah
> Voltage	: 18 V d,c,
> Weight	: approx. 0.4 kg
Charger	
> Model no.	: MC18BS-Li
> Rated input	: 220 - 240 V~, 50/60 Hz, 37 W
> Rated output	: 20V d.c. , 1.5A
> Charging time	: approx. 1h
> Weight	: approx. 0.2 kg
Sound values	
> Sound pressure level L_{pA}	: 87 dB(A)
> Sound power level L_{WA}	: 98 dB(A)
> Uncertainty K_{pA} , K_{WA}	: 3 dB(A)
Hand arm vibration values	
> Drilling into metal $a_{h,D}$: 2.2 m/s ²
> Impact drill into concrete	: 10.8 m/s²
> Uncertainty K	: 1.5 m/s ²

The sound intensity level for the operator may exceed 80 dB(A) and ear protection measures are necessary.

Rating Label Explanation

MSDD18-Li-2 = MODEL NUMBER

MS = MacAllister(Brand)

DD = Drill/Driver

18 = 18 Volts

Li = Lithium Ion battery

2 = 2 speed

Before you start

Unpacking

1. Unpack all parts and lay them on a flat, stable surface.
2. Remove all packing materials and shipping devices if applicable.
3. Make sure the delivery contents are complete and free of any damage. If you find that parts are missing or show damage do not use the product but contact your dealer. Using an incomplete or damaged product represents a hazard to people and property.
4. Ensure that you have all the accessories and tools needed for assembly and operation. This also includes suitable personal protective equipment.



WARNING! The product and the packaging are not children's toys! Children must not play with plastic bags, sheets and small parts! There is a danger of choking and suffocation!

You will need

(items not supplied)

- > suitable personal protective equipment
- > suitable drill bits
- > suitable driver bits
- > bit adaptor
- > cooling lubricant (for drilling into metal)

(Items supplied)

- > 2x battery pack (8)
- > 1x charger (12)

Setup



WARNING! The product must be fully assembled before operation! Do not use a product that is only partly assembled or assembled with damaged parts! Follow the assembly instructions step-by-step and use the pictures provided as a visual guide to easily assemble the product!



Do not connect the product to power supply before it is completely assembled!

Drill/Driver bits

Different drill and driver bits can be used with this product depending on the material being worked with.



WARNING! Always use drill bits according to the intended use! For example, never use a drill bit intended for working on wood for working on metal or vice versa!



Observe the technical requirements of this product (see section Technical specifications) when purchasing and using drill bits!
Some drill bits become hot during use! Handle them carefully! Wear protective gloves when handling drill bits in order to avoid injuries like burns!

Inserting

- > Turn the chuck sleeve (2) anticlockwise until the chuck jaws are opened wide enough to insert the drill bit (Fig. 1).
- > Insert the drill bit all the way to the stop (Fig. 2). If using a 25 mm driver bit, insert it into the socket of a bit holder.
- > Turn the chuck sleeve (2) clockwise until the drill bit is properly fastened in the chuck jaws (Fig. 3).

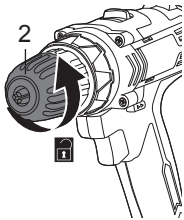

Fig. 1

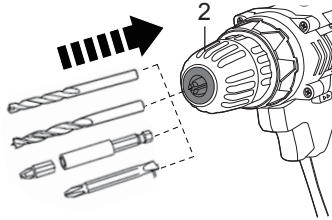

Fig. 2

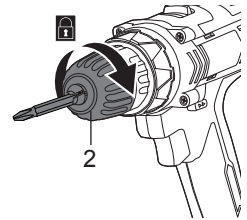

Fig. 3



WARNING! After short operation, switch the product off and check once again that the bit is properly fastened! Caution, the bit could be hot!



Removing / Replacing

- > Turn the chuck sleeve (2) anticlockwise until the chuck jaws are opened wide enough to remove the bit.
- > Remove the bit and insert a new one as described above if desired.

Battery pack

Release / Attach

- > Lock the ON/OFF switch (6) to avoid accidental starting by moving the forward / reverse rotation control (5) into the middle position (see section “Product functions – Forward / reverse rotation control”).
- > To remove the battery, press the release button (9) and pull out the battery pack (8) from the product (Fig. 4).
- > To attach the battery to the product, align the battery pack (8) with the sliding slots of the battery docking port and slide the battery pack in. Ensure it clicks in place (Fig. 5).

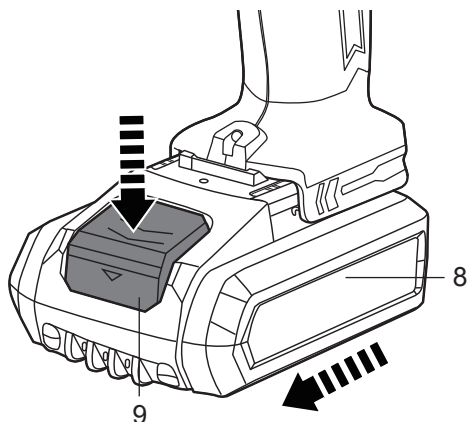

Fig. 4

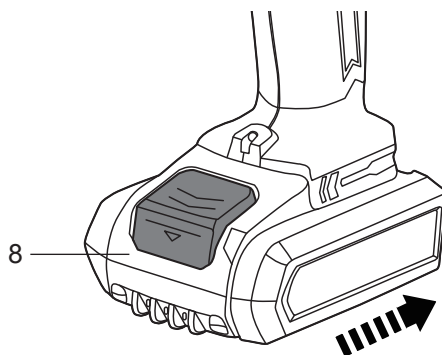

Fig. 5

Charging the battery



WARNING! Do not use any charger other than that specifically provided for use with the product. Check the voltage! The voltage must comply with the information on the rating label!.



NOTES:

If the battery pack is very hot you must remove your battery pack from the charger and allow time for the battery to cool down before recharging.

The battery in your new tool is not charged when it leaves the plant. Therefore, it must be fully charged before using the first time.

Please charge the battery to reach full or no less than half charge before storage. If the tool will not be used for long periods of time, charge the battery every 3-6 months.

- > Slide the battery pack (8) into the charger base (11) until it locks in place (Fig. 6).
- > Connect the charger (12) to the power supply. The indicator light (10) lights in red when battery is charging and green when charging is finished.
- > After charging finished, disconnect the charger (12) from power supply and remove battery pack (8) from the charger base (11) by pressing the release button (9) and pulling out the battery pack (8) (Fig. 7).

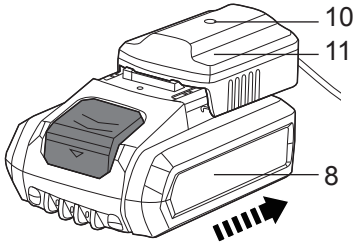

Fig. 6

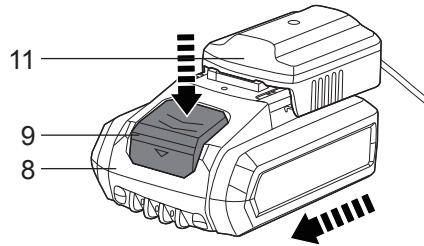
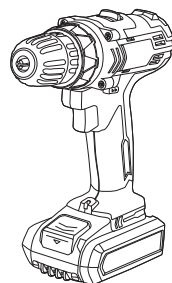

Fig. 7

In more detail...



Intended use	21
Product functions	21
General operation	26
Care and maintenance	27
Trouble shooting	29
Recycling and disposal	30
Guarantee	30
EC declaration of conformity	31



Intended use

The product is intended for driving in and loosening screws as well as for drilling in wood, metal, plastic. This product is not intended for impact drilling in brickwork/masonry. It should not be used for working on materials that are dangerous to health. It must not be used for tightening or loosening car wheel nuts.

For safety reasons it is essential to read the entire instruction manual before first operation and to observe all the instructions therein.

Product functions

Switching ON/OFF (Fig. 8)

- > Switch the product on by pressing the ON/OFF switch (6).
- > Switch the product off by releasing the ON/OFF switch (6). It is also a variable speed switch that delivers higher speed and torque with increased trigger pressure. Speed is controlled by the amount of switch trigger depression.

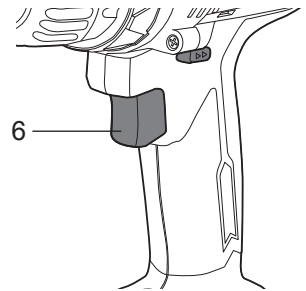

Fig. 8



WARNING! Do not operate for long periods at low speed because excess heat will be produced internally. When overload occurs, release the ON/OFF switch immediately to avoid the motor overheating.

Forward / reverse rotation control

Change the rotational direction from forward to reverse by pressing the forward / reverse rotation control (5).





WARNING! Only change the rotational direction when the product is switched off and has come to a complete stop! Always ensure that the forward / reverse rotation control is adjusted to the correct position depending on the intended operation!

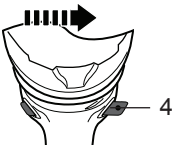
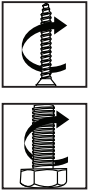
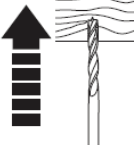
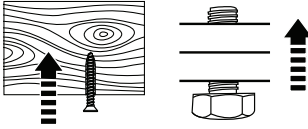
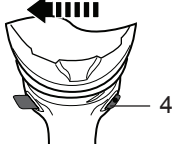
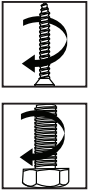
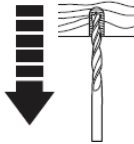
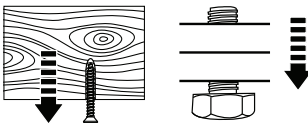
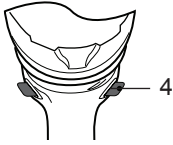

Always push the forward / reverse rotation control as far as it will go! Do not use the product with the control switch in any other position!

- In more detail . . .
- > Move the forward / reverse rotation control switch (5) to the left (as seen from the operator's position) in order to use the product in a clockwise rotational mode (Fig. 9).
 - > Move the forward / reverse rotation control switch (4) to the right (as seen from the operator's position) in order to use the product in anticlockwise rotational mode (Fig. 10).
 - > Move the forward / reverse rotation control switch (4) to the center position to lock the on/off switch and avoid accidental starting (Fig. 11).

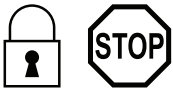
Position	Rotational direction	Application	
 <p>Fig. 9</p>		 <p>drilling into material</p>	 <p>screw driving</p>
 <p>Fig. 10</p>		 <p>loosen jammed drill bits</p>	 <p>remove screw</p>
 <p>Fig. 11</p>		 <p>lock the on/off switch and avoid accidental starting</p>	



NOTE: If you are using the product for the first time after changing the rotational direction, a locking sound may be heard. This is normal and does not represent a defect.

Automatic work light (Fig. 12)

The work light (1) will automatically illuminate by pressing the ON/OFF switch (6).

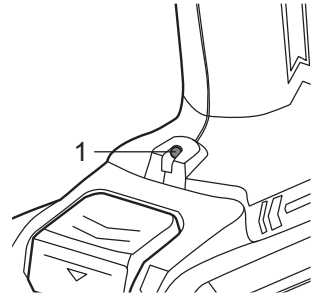

Fig. 12



WARNING! Do not look directly into the light.

Two-speed gear control

The two-speed gear control (4) is used to switch between two working modes. When the gear is set to position **1**, the speed will decrease and the drill will have greater power and torque. When the gear is set to position **2**, the speed will increase and the drill will have less power and torque (Fig. 13)

Gear position	Description
1	Low speed range for screwdriving or working with large drilling diameter
2	High speed range for working with small drilling diameter

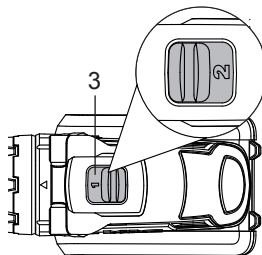



Fig. 13



WARNING! To prevent gear damage, always allow the chuck to come to a complete stop before changing the direction of rotation or the two-speed gear control. When overload occurs frequently on the high speed gear, switch to the low speed gear to avoid the motor overheating.

Torque adjustment (Fig. 14)

The torque is adjusted by rotating the torque adjustment ring (3). The torque is greater when the torque adjustment ring is set on a higher setting. The torque is lower when the torque adjustment ring is set on a lower setting.

Torque	Description
1 - 4	for driving small screws
5 - 9	for driving screws into soft material
10 - 14	for driving screws into soft and hard material
15 - 18	for driving screws into hard wood
	for heavy drilling in wood, plastic and metal

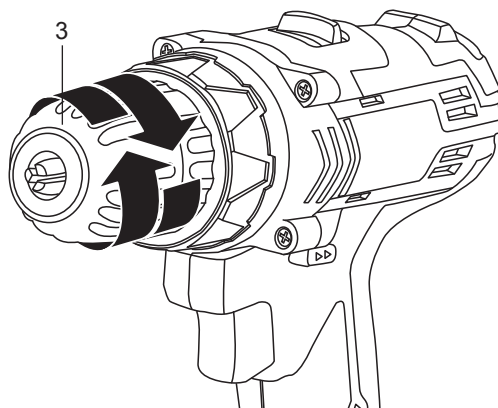

Fig. 14

Automatic spindle lock (Fig. 15)

The automatic spindle lock allows you to use it as a regular screwdriver. You can give an extra twist to firmly tighten a screw, loosen a very tight screw or continue working when the battery energy has expired. For manual screwdriver purposes, the chuck is automatically locked when the tool is off

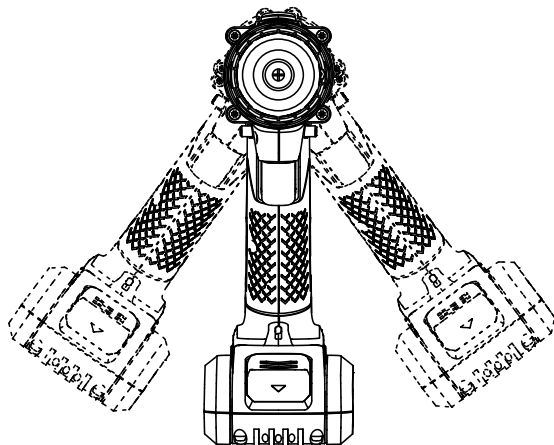

Fig. 15

General operation

- > Check the product, its battery pack and charger as well as accessories for damage before each use. Do not use the product if it is damaged or shows wear.
- > Double check that the accessories and attachments are properly fixed.
- > Always hold the product on its handle. Keep the handle dry to ensure safe support.
- > Ensure that the air vents are always unobstructed and clear. Clean them if necessary with a soft brush. Blocked air vents may lead to overheating and damage the product.
- > Switch the product off immediately if you are disturbed while working by other people entering the working area. Always let the product come to complete stop before putting it down.
- > Do not overwork yourself. Take regular breaks to ensure you can concentrate on the work and have full control over the product.



WARNING! Keep in mind that there are buried objects hidden in every household! Ensure that there are no gas, water or power lines hidden in the working area that may be hit before operation – danger of electrical shock and serious damage to people and property! Use a suitable detector to trace such objects in advance!

Drilling

- > Set the torque ring to drilling mode when drilling into wood, plastic or metal.
- > Always hold the product perpendicular to the point to be drilled. Holding it at an angle may cause slipping or jamming of the drill bit.
- > Always place the drill tip directly on the point to be drilled first and then switch the product on.
- > Pre-drill larger holes with a small diameter drill bit first. Doing so makes drilling with a larger diameter drill bit easier.
- > Do not always drill at top speed. This unnecessarily increases the wear and tear of the product and drill bit.
- > Remove blocked and stuck drill bits by changing the rotational direction.

Drilling into plastic and metal

- > Punch the drilling point before operation in order to avoid slipping of the drill.
- > Use a metal drill bit for drilling into plastic and metal. Select a low speed and where necessary use a cooling lubricant that is available at your specialist dealer.

Screw driving

- > Set the torque ring to screw driving mode (numbers).
- > Adjust the torque setting according to the screw size and workpiece material.
- > Pre-drill the holes with a smaller diameter of the screw to be screwed.

- > Hold the product perpendicular to the screw to be screwed in/out. Holding it at an angle may cause slipping or jamming of the driver bit.
- > Place the tip of the driver bit directly on the screw first and then switch the product on. Only apply as much pressure as necessary to keep the screw in place and the driver bit in contact with the screw head. Too much pressure will cause damage to the screw head and driver bit; too little pressure will cause the driver bit to slide away.
- > Remove blocked and stuck screws by changing the rotational direction.

Care and maintenance

After use

- > Switch the product off, remove the battery pack and let it cool down.
- > Check, clean and store the product as described below.

The golden rules for care



WARNING! Always switch the product off, remove the battery pack and let the product cool down before performing inspection, maintenance and cleaning work!



- > Keep the product clean. Remove debris from it after each use and before storage.
- > Regular and proper cleaning will help ensure safe use and prolong the life of the product.
- > Inspect the product before each use for worn and damaged parts. Do not operate it if you find broken and worn parts.



WARNING! Only perform repairs and maintenance work according to these instructions! All further works must be performed by a qualified specialist!

General cleaning

- > Clean the product with a dry cloth. Use a brush for areas that are hard to reach.
- > In particular clean the air vents after every use with a cloth and brush.
- > Remove stubborn dirt with high pressure air (max. 3 bar).



NOTE: Do not use chemical, alkaline, abrasive or other aggressive detergents or disinfectants to clean this product as they might be harmful to its surfaces.

- > Check for worn or damaged parts. Replace worn parts as necessary or contact an authorised service centre for repair before using the product again.

Maintenance

Before and after each use, check the product and accessories (or attachments) for wear and damage. If required, exchange them for new ones as described in this instruction manual. Observe the technical requirements.

Repair

This product does not contain any parts that can be repaired by the consumer. Contact an authorised service centre or a similarly qualified person to have it checked and repaired.

Storage

- > Switch the product off and remove the battery pack.
- > Clean the product as described above.
- > Store the product and its accessories in a dark, dry, frost-free, well-ventilated place.
- > Always store the product in a place that is inaccessible to children. The ideal storage temperature is between 10°C and 30°C.
- > We recommend using the original package for storage or covering the product with a suitable cloth or enclosure to protect it against dust.

Transportation

- > Switch the product off and remove the battery pack.
- > Attach transportation guards, if applicable.
- > Always carry the product by its handle.
- > Protect the product from any heavy impact or strong vibrations which may occur during transportation in vehicles.
- > Secure the product to prevent it from slipping or falling over.

Troubleshooting

Suspected malfunctions are often due to causes that the users can fix themselves. Therefore, check the product using this section. In most cases the problem can be solved quickly.



WARNING! Only perform the steps described within these instructions! All further inspection, maintenance and repair work must be performed by an authorised service center or a similarly qualified specialist if you cannot solve the problem yourself!

Problem	Possible cause	Solution
1. Product does not start	1.1. Forward / reverse rotation control switch at center lock position 1.2. Battery pack not properly attached 1.3. Battery pack discharged 1.4. Battery pack damaged 1.5. Other electrical defect to the product	1.1. Push forward / reverse rotation control switch to left / right 1.2. Attach properly 1.3. Remove and charge battery pack 1.4. Check by a specialist electrician 1.5. Check by a specialist electrician
2. Product does not reach full power	2.1. Battery pack capacity too low 2.2. Air vents are blocked	2.1. Charge battery pack 2.2. Clean the air vents
3. Unsatisfactory result	3.1. Driver/drill bit is worn 3.2. Driver/drill bit not suitable for intended operation	3.1. Replace with a new one 3.2. Use suitable driver/drill bit
4. Product suddenly stops	4.1. Product overloaded 4.2. Battery pack discharged 4.3. Battery too hot	4.1. Remove the product from the workpiece and switch it on again 4.2. Remove and charge battery pack 4.3. Remove battery pack and let it cool down

Recycling and disposal



Waste electrical products should not be disposed of with household waste. Please recycle where facilities exist. Check with your local Authority or local store for recycling advice.

Disposal of an exhausted battery pack



To preserve natural resources, please recycle or dispose of the battery pack properly. Consult your local waste authority for information regarding available recycling and/or disposal options. Discharge your battery pack by operating your tool, then remove the battery pack from the tool and cover the battery pack connections with heavy duty adhesive tape to prevent short circuit and energy discharge.

Do not attempt to open or remove any of the components.

Guarantee

At MacAllister we take special care to select high quality materials and use manufacturing techniques that allow us to create ranges of products incorporating design and durability. That's why we offer a 2 year guarantee against manufacturing defects on our MacAllister power tool products.

This power tool is guaranteed for 2 years from the date of purchase, if bought in store, delivered or if bought online. You may only make a claim under this guarantee upon presentation of your sales receipt or purchase invoice. Please keep your proof of purchase in a safe place.

This guarantee covers product failures and malfunctions provided the MacAllister power tool was used for the purpose for which it is intended and subject to installation, cleaning, care and maintenance in accordance with standard practice and with the information contained above and in the user manual. This guarantee does not cover defects and damage caused by or resulting from:

- Normal wear and tear
- Overload, misuse or neglect
- Repairs attempted by anyone other than an authorised agent
- Cosmetic damage
- Damage caused by foreign objects, substances or accidents
- Accidental damage or modification
- Failure to follow manufacturer's guidelines
- Loss of use of the goods

This guarantee is limited to parts recognised as defective. It does not, in any case, cover ancillary costs (movement, labour) and direct and indirect damage.

If the MacAllister power tool is defective during the guarantee period, then we reserve the right, at our discretion, to replace the item with a product of equivalent quality and functionality or to provide a refund.

This guarantee only applies to the country of purchase or delivery and is not transferrable to any other countries. This guarantee is non-transferrable to any other person or product. Relevant local law will apply to this guarantee.

Guarantee related queries should be addressed to a store affiliated with the distributor from where you purchased the MacAllister power tool.

This guarantee is in addition to and does not affect your statutory rights relating to faulty goods as a consumer.

EC declaration of conformity



We

Kingfisher International Products Limited

3 Sheldon Square London W2 6PX United Kingdom

Declare that the product:

18V cordless drill MSDD18-Li-2

Serial number: 000001-999999

Complies with the essential health and safety requirements of the following directives:

2006/42/EC The Machinery Directive

References to the following harmonized standard were made:

EN 60745-1: 2009+A11:2010

EN 60745-2-1:2010

2014/30/EU Electromagnetic Compatibility Directive

References to the following harmonized standard were made:

EN 55014-1:2017

EN 55014-2:2015

Charger MC18BS-Li

EN 55014-1:2017

EN 55014-2:2015

EN 61000-3-2:2014

EN 61000-3-3:2013

2014/35/EU Low Voltage Directive

References to the following harmonized standard were made:

EN 60335-1: 2012 +A11: 2014+A13:2017

EN 60335-2-29: 2004 +A2: 2010

EN 62233 :2008

2011/65/EU Restrictions of the Use of Certain Hazardous Substances in
Electrical and Electronic Equipment

Authorised signatory and technical file holder:

Kingfisher International Products Limited

3 Sheldon Square

London W2 6PX

United Kingdom

Lisa Davis
Group Quality Director
on: 18/06/2018

A handwritten signature in cursive script that reads "Lisa Davis".



**Manufacturer • Fabricant • Producent • Hersteller •
Producator • Fabricante:**

Kingfisher International Products Limited,
3 Sheldon Square, London, W2 6PX,
United Kingdom
www.kingfisher.com/products

Distributor:

B&Q plc,
Chandlers Ford, Hants, SO53 3LE
United Kingdom
www.diy.com



Screwfix Direct Limited,
Trade House, Mead Avenue,
Yeovil, BA22 8RT, United Kingdom
www.screwfix.com

To view instruction manuals online,
visit www.kingfisher.com/products.