

HYUNDAI
POWER PRODUCTS

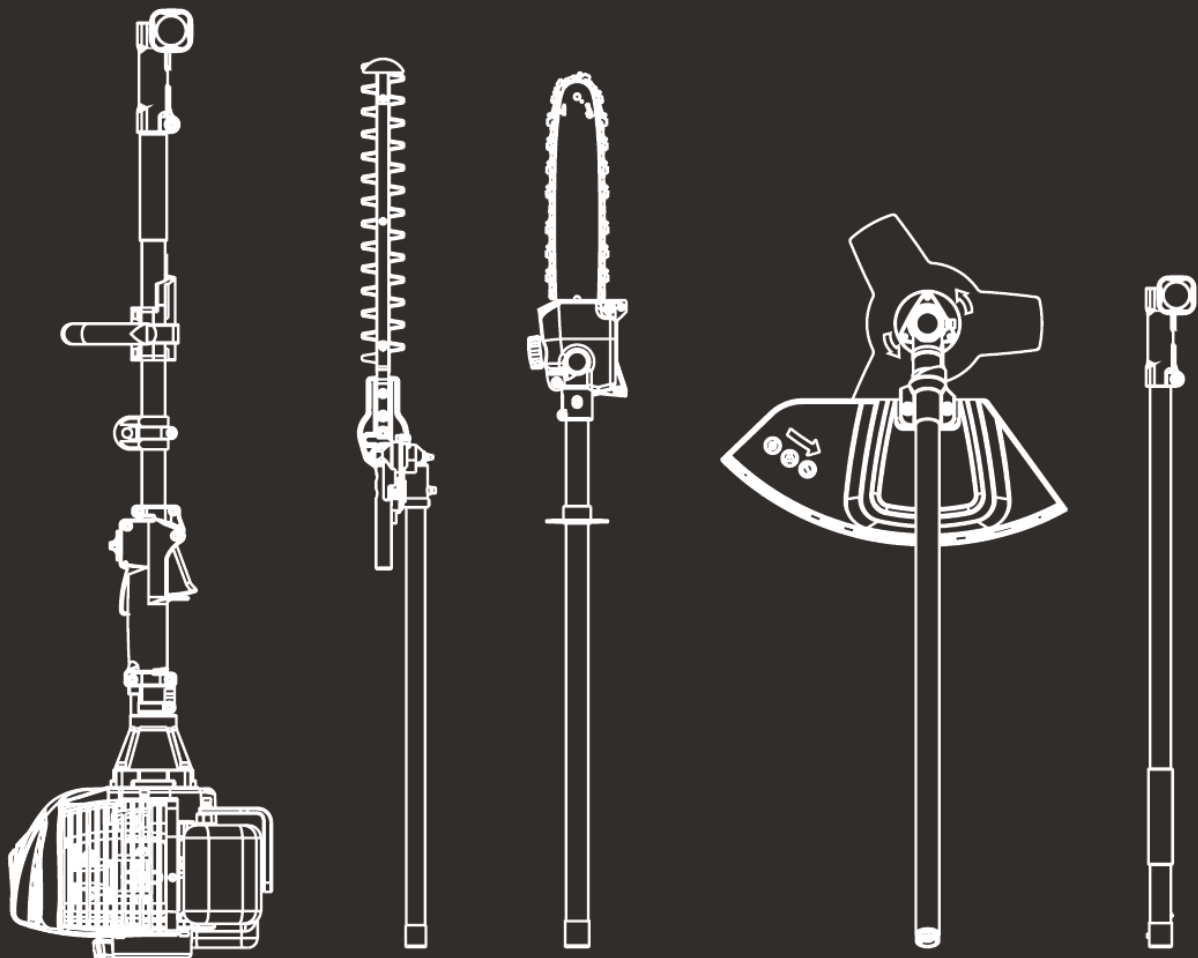

5-IN-1 PETROL MULTI-TOOL HYMT5200X

Instruction Manual



Introduction

Thank You For Purchasing Your HYUNDAI Product

We work very hard to give all of our customers the best possible service. If you have any problems, before leaving negative feedback, please contact us to give us a chance to resolve the issue. We would be delighted if you left us positive feedback! Thank you for purchasing this product.

Important!



⚠ WARNING : READ THE INSTRUCTION BOOKLET THOROUGHLY BEFORE USING THE MACHINE. Keep for future reference and pass it on if the machine is loaned or sold to another user.

This manual has been produced by Hyundai Power Products and should be kept with the product. Please read and understand these instructions before you use your product. Failure to do this may result in personal injury or damage to the product.

The safety precautions and warnings are to ensure your safety and protect you from harm or damage to the product.

The information contained in this manual was accurate at the time of production, however HYUNDAI Power Products may make modifications to the product without notification.



Contents

Safety Information.....	4-21	Starting / Stopping.....	40-41
Understand Your Machine.....	4	Maintenance.....	42-50
Personal Safety.....	5	Maintenance Safety.....	42
Inspect Your Machine.....	6	Checking Your Machine.....	42
Work Area.....	7	Cleaning.....	43
During Use.....	8-9	Storage.....	44-45
Pole Saw Safety.....	10	Transportation.....	45
Hedge trimmer Safety.....	10	Pole Saw Oil.....	46
Grass Trimmer Safety.....	10	Pole Saw Chain Sharpening.....	46
Brush Cutter Safety.....	10	Air Filter.....	47
Engine Safety.....	11	Spark Plug.....	48
Carbon Monoxide.....	12	Lubricating The Gears.....	48
Batteries.....	13	Lubricating The Chain.....	49
Fuel Safety.....	14-15	Tightening And Checking The Saw Chain.....	49
Electrical Safety.....	16	Maintenance Schedules.....	50
Vibrations.....	17	Troubleshooting.....	51
Noise.....	17	Technical Data.....	52-53
Personal Safety.....	18	Recycling And Disposal.....	54
Intended Use.....	19	Declaration Of Conformity.....	55
Symbols On The Machine.....	20-21	Useful Information.....	56
Features.....	22-23	Our YouTube Channel.....	56
Unboxing.....	24	Warranty.....	56
Assembly.....	25-31	Manual Updates.....	56
Assembly Safety.....	25	Returning Your Product.....	56
Engine Unit Handle.....	26	Leaving A Review.....	56
Harness.....	27	Ordering Spare Parts.....	56
Grass Trimmer Attachment.....	28	Our Product Range.....	57
Cutting Blade Attachment.....	29	Product Information.....	58
Pole saw Attachment.....	30-31	Service Record.....	58
Preparation.....	32-33	Contact Us.....	59
Before Each Use.....	32		
Fuel And Oil.....	33		
Operation.....	34-39		
Connecting Attachments To Motor Unit.....	34		
Connecting Extension Boom.....	34		
Using Grass Trimmer.....	35		
Using The Pruning Saw.....	36		
Preventing Kickback.....	36		
Using The Cutting Blade.....	37		
Using The Hedge Trimmer.....	37		
Re-Filling Trimmer Line.....	38-39		
Extending Trimmer Line.....	39		



Safety Information

Safety

No list of safety guidelines can be complete. Every environment is different. Always consider safety first, as it applies to your individual working conditions. Use this and other machinery with caution and respect. Failure to do so could result in serious injury, damage to equipment, or poor work results.

Some or all of the following - warning signs and symbols may appear throughout this manual. You **MUST** adhere to their warnings. Failure to do so may result in personal injury to yourself or those around you.

DANGER

Indicates a hazard, which, if not avoided, could result in serious injury or death.

WARNING

Indicates a hazard, which, if not avoided, could result in serious injury.

CAUTION

Indicates a hazard which, if not avoided, might result in minor or moderate injury.

Understand Your Machine

- **WARNING!** You must read these instructions carefully before operating the machine. Make sure that you are familiar with the controls and properly operate the machine. You must learn how to stop the machine quickly. If you do not follow the warnings and instructions, it may result in fire and/or serious injury. Make sure to save all warnings and instructions for future reference.
- Read this manual and labels affixed to the machine to understand its limitations and potential hazards.
- Be thoroughly familiar with the controls and their proper operation. Know how to stop the machine and disengage the controls quickly.
- If the unit is to be used by someone other than original purchaser, or is to be loaned, rented, or sold, always provide this manual and any needed safety training before operation. The user can prevent and is responsible for accidents or injuries that may occur to themselves, to other people, or to property.
- Do not force the machine beyond its limits. Use the correct machine for your application.
- Know how to stop the machine quickly in case of emergency. Understand the use of all controls.
- ALL MAINTENANCE other than that listed in this manual, should be carried out by professionally trained and certified personnel.
- When using this machine for the first time and before actual work, you **MUST** learn how to handle the machine from an experienced or skilled person.



Safety Information

⚠ Personal Safety

- **WARNING!** Never allow children or people unfamiliar with these instructions to use the product. Local regulations can restrict the minimum age of the operator.
- Keep children, pets, and other people not using the unit away from the work area (at least 15m). Be alert and shut off the unit if anyone enters work area. Keep children under the watchful care of a responsible adult.
- Stay alert, watch what you are doing and use common sense when operating the machine. Never operate the machine when unwell or tired, or if you have taken alcohol, medicine, drugs or any substances which may slow your reflexes and compromise judgment. A moment of inattention while operating the machine may result in serious personal injury.
- Appropriate Personal Protective Equipment (PPE), **MUST** be worn at all times when operating or repairing the machine. Always wear anti-slip and resistant work footwear and long trousers while using the machine. Do not use the machine when barefoot, wearing sandals or similar lightweight footwear. Do not wear chains, bracelets or clothing that is loose fitting or hanging ties or cords. Tie long hair back. Always wear protective earplugs. Loose clothes, jewellery, or long hair can be caught in moving parts. Protect eyes, face, and head from objects that may be thrown from the unit. Always wear safety goggles or safety glasses with side shields when operating.
- Always keep hands and feet away from all moving parts during operation. Moving parts can cut or crush body parts. Always keep hands and feet away from all pinch points.
- Do not touch parts that might be hot from operation. Allow parts to cool before attempting to maintain, adjust, or service.
- Do not overreach. Keep proper footing and balance at all times. This enables better control of the machine in unexpected situations. Extending your body too far can result in a loss of balance and you may fall which will result in injury.
- Never place any part of your body where it would be in danger if movement should occur during assembly, installation, and operation, maintenance, repairing or moving.
- Start the machine carefully according to instructions and with feet away from the moving parts.
- Do not place your hands or feet near or under rotating parts. Keep away from any discharge openings.
- Keep in mind that the operator or user is responsible for accidents, hazards or unexpected events involving the machine that occur to other people or their property. It is the responsibility of the user to assess the potential risk of the area where work is being carried out. The operator or user must take all necessary precautions to ensure their own safety and that of others, especially on slopes or rough, slippery and unstable ground.
- After 30 minutes of work, take a break of at least one hour.



Safety Information

▲ Inspect Your Machine

- You must check the general condition of the machine before use. Keep guards in place and in working order. Make sure all nuts, bolts, etc., are securely tightened.
- Never operate the machine when it is in need of repair or is in poor mechanical condition. Replace damaged, missing, or failed parts before using it. Check for fuel leaks. Keep the machine in safe working condition.
- Do not use the machine if the engine's switch does not turn off the engine when running. Any petrol powered machine that can't be controlled with the engine switch is dangerous and must be replaced.
- Regularly check to see that keys and adjusting wrenches are removed from the machine area before starting it. A wrench or a key that is left attached to a rotating part of the machine may result in personal injury.
- If the machine should start to vibrate abnormally, stop the engine and check immediately for the cause. Vibration is generally a warning sign of trouble.
- Avoid accidental starting. Be sure the engine's switch is off before transporting the machine or performing any maintenance or service on the unit. Transporting or performing maintenance or service on a machine with its switch on invites accidents.
- Do not tamper with or disable safety systems.
- Only use manufacturer-recommended attachments.
- Before using, always visually inspect to see that the tools are not worn out or damaged. Replace worn out or damaged elements and bolts in set to preserve balance.
- Keep the machine in good operating condition. Operating the machine in poor or questionable condition could result in serious injury.
- Be sure all safety devices are in working order and warning labels are in place. These items are installed for your safety.
- Keep cutting tools sharp and clean. Properly maintained cutting tools with sharp cutting edges are less likely to bind and are easier to control.



Safety Information

▲ Work Area

- Make sure you thoroughly inspect the entire work area and remove all objects and anything that could be thrown by the machine or could damage the engine or machine (branches, stones, wire, toys, etc). Attempting to clear the work area whilst using the machine will reduce your concentration and creates a trip hazard. Any liquid spilled on the floor may result in you slipping.
- You must only work in daylight or with good artificial light in good visibility conditions. Do not work at night, at times of heavy fog, or at any other times when your field of vision might be limited and it would be difficult to gain a clear view of the area.
- Keep people, children and animals away from the working area.
- Operate on flat, level ground.
- DO NOT work on wet ground. If there has been heavy rain on the working site, wait until the ground has dried up.
- You must pay special attention when approaching obstacles that could compromise visibility.
- Make sure on slopes you have a steady foothold.
- Never park the machine in a place with unstable ground which could give way.
- You must be careful near ravines, ditches or embankments.
- Exercise extreme caution when operating on or crossing gravel drives, walks, or roads. Stay alert for hidden hazards or traffic.
- Pay the utmost attention when working on frozen ground as the machine may tend to skid.
- Do not work in the rain, when there is a thunderstorm or lightning risk, at times of strong or gale force winds, or at any other times when the weather conditions might make it unsafe to use this product. If there is bad weather conditions, do not use the machine.
- Do not use the appliance in a potentially explosive environment containing flammable liquids, gases or dusts. The sparks generated by the machine could ignite the vapours or gases.



Safety Information

⚠ During Use

- Always hold the unit with both hands when operating. Keep a firm grip on the handlebars
- Do not operate the machine in confined areas where there may be a risk of crushing the operator between the machine and another object.
- Walk, never run with the machine.
- **WARNING!** If something breaks or an accident happens whilst working, you must turn off the engine immediately and move the machine away to prevent further damage. If an accident happens with injuries or third parties are injured, carry out the first aid measures most suitable for the situation immediately and contact the medical authorities for any necessary health care. Carefully remove any debris that might cause damage or harm persons or animals should it not be seen.
- Never operate the machine at a fast pace.
- The excessive speed of movement or the absence of maintenance have a significant influence on noise emissions and vibrations. It is necessary to take preventive steps to eliminate possible damage due to high levels of noise and stress from vibration. You must maintain the machine well, wear ear protection and take breaks from working.
- After striking a foreign object, stop the engine immediately, remove the spark plug cap and inspect the machine thoroughly for damage. Repair the damage before continuing.
- Always disengage the levers, turn off the engine, and remove the spark plug, when the unit is left unattended.
- Never attempt to make any adjustments, while the engine is running.
- Never attempt to move the machine in any way other than intended for normal use while the engine is running.
- You must disengage the blade, switch off the engine and unplug the spark plug cable (making sure that all moving parts are stationary):
 - Before refuelling.
 - After striking a foreign object, you must inspect the machine for damage and make repairs before using it again.
 - Before cleaning, checking or working on the machine.
 - Before clearing blockages.
 - When transporting the machine.
 - Whenever you leave the machine unattended.
- Never use the appliance while standing on a ladder.
- Do not use the appliance near power lines. Maintain a minimum distance of 10m to above ground power lines.



Safety Information

⚠ During Use (Continued)

- Be aware of your environment and all possible hazards that you may be unable to hear while using the machine.
- Keep an eye not only on the branches being cut, but also on fallen material, to avoid tripping.
- Hold the power tool only by the insulated grips as the cutting blades could come into contact with hidden power lines. Contact between the blades and a live wire may make exposed metal parts of the power tool live and could give the operator an electric shock.
- Keep your hands away from the cutting blades. Do not attempt to clear clippings or hold onto the material to be cut while the blades are still in motion. Remove any jammed clippings only when the appliance has been switched off. A moment of inattention while operating the hedge trimmer may result in serious personal injury.
- Wait until the tool has come to a standstill before putting it down.
- After making settings to the working angle, check whether both setting levers are clicked firmly into place. If one of the setting levers remains open, the second could be unintentionally be released by a branch and the cutter bar could swing down.
- Always ensure that the handles are dry and clean and that no petrol mixture is present.
- Do not touch the exhaust.
- Always hold the appliance with both hands. Your thumbs and fingers should encircle the handles.
- Do not cut any wood that is lying on the ground and do not attempt to saw roots that are protruding from the soil. Avoid immersing the saw chain in the soil at all costs, as this could blunt the saw chain.
- Do not use the appliance unless the appropriate protective guard has been installed and is in good condition.
- When starting and operating the appliance, ensure that it does not come into contact with the ground, stones, wire or other foreign material. Switch off the appliance before you put it down.
- The cutting blade flings objects and soil with great force. These can blind or cause other injuries. Wear eye, face and leg protection. Always remove objects from the work area before using the cutting blade.
- The cutting blade continues running after the throttle lever has been released. A running-down cutting blade can inflict cuts to yourself or other people standing nearby. Turn the engine off and make sure that the cutting blade has come to a complete stop before performing any work on the cutting blade.



Safety Information

⚠ Pole Saw Safety

- To avoid injuries due to falling branches, do not stand under the branches that you want to cut off. Be aware of branches that may spring back and cause injuries. Work at an angle of approximately 60°.
- Be aware that an appliance kickback can occur.
- Keep an eye not only on the branches being cut, but also on fallen material, to avoid tripping.

⚠ Hedge Trimmer Safety

- While trimming, ensure that you do not come into contact with objects such as fence wire or plant supports. They could cause damage to the cutter bar. Inspect the hedge to be cut carefully and remove any wires or other foreign bodies.
- Never touch the cutter bar of the hedge trimmer.
- Never grasp the hedge trimmer by the safety guards.
- Between tasks or after completion of a task, do not set the cutter bar down on its tip as this could cause damage to the cutter bar.

⚠ Grass Trimmer Safety

- Always use the enclosed shoulder strap.
- Before starting the engine, make sure that the trimmer is not in contact with any obstacles.
- Guide the grass trimmer to the desired height. Avoid contact with small objects (e.g. stones) when using the trimmer.
- Always hold the trimmer on the ground when the appliance is in operation.
- The relevant plastic protective guard for the cutting blade or filament operation must be installed when working with the appliance in order to prevent objects from being flung away.

⚠ Brush Cutter Safety

- When working with the 3-tooth cutting blade there is a risk of kickback if the blade strikes against solid obstacles (tree trunks, branches, tree stumps, rocks or similar). This will result in the cutting tool being catapulted back against the direction of rotation. This can lead to the loss of control of the appliance. Do not use the cutting blade near fences, metal posts, boundary stones or foundations.



Safety Information

▲ Engine Safety

- This machine is equipped with an internal combustion engine. Do not use on, or near, forest-covered or brush-covered land unless the exhaust system is equipped with a spark arrester meeting applicable local, state, or federal laws.
- A spark arrester, if used, must be maintained in effective working order by the operator.
- Never start or run the engine inside a closed area. The exhaust fumes are dangerous, containing carbon monoxide, an odorless and deadly gas. Operate this unit only in a well-ventilated outdoor area. (See carbon monoxide safety).
- Do not tamper with the engine in an effort to get it to run at higher speeds. The maximum engine speed is preset by the manufacturer and is within safety limits.
- Keep a fire extinguisher on hand when operating this machine in dry areas as a precautionary measure.
- Never leave the operating position when the engine is running.
- The engine parts get very hot when running, do not touch. Danger of burns.
- Follow the instructions to ignite the engine carefully whilst keeping feet away from moving parts.
- Never incline the machine during ignition. Ignite the machine on a flat surface without obstacles or high grass.
- Do not over-rev the engine or change the engine settings.
- Never pick up or carry the machine while the engine is running.
- Stop the engine whenever you leave the machine, or before refuelling, when cleaning or while maintaining.
- Reduce the throttle setting during engine shut down and, if the engine is provided with a shut-off valve, turn the fuel off at the conclusion of working.
- Do not tilt the lawnmower when starting the engine.



Safety Information

⚠ Carbon Monoxide

⚠ DANGER!

Engine exhaust fumes contain Carbon Monoxide. This is a poisonous gas and can kill in minutes. **NEVER** use inside a building or in an area with poor ventilation. **NEVER** use inside a confined space, such as but not limited to a house, garage, vehicle, boat or tent. **ONLY** use outside and far away from windows, doors and vents.

CARBON MONOXIDE IS A COLOURLESS, ODOURLESS GAS. INHALING THIS GAS CAN CAUSE DEATH OR SERIOUS LONG-TERM HEALTH PROBLEMS SUCH AS BRAIN DAMAGE.

Never operate the engine in a confined space where dangerous carbon monoxide fumes can develop. All ignition operations have to be effected in an open or well-ventilated area. Always remember that exhaust fumes are toxic.

The symptoms of carbon monoxide poisoning can include but are not limited to the following; Headaches, dizziness, nausea, breathlessness, collapsing or loss of consciousness.

Carbon monoxide poisoning symptoms are similar to flu, food poisoning, viral infections and simply tiredness. It is quite common for people to mistake this very dangerous poisoning for something else.

To avoid carbon monoxide poisoning **DO NOT** use Petrol/Diesel powered equipment inside any of the following; Home, garage, tent, camper van, mobile home, caravan or boat. **DO NOT** use in an enclosed area or moving vehicle. This is not exhaustive and if you are in any doubt contact your dealer.

If you think you have or someone around you has been affected by carbon monoxide poisoning; Get them fresh air immediately, by leaving the affected area or by opening doors and windows. If safe and practical to do so make sure that the machine is turned off. **DO NOT** enter a room you suspect of having carbon monoxide present – instead call the emergency services.

Contact a Doctor immediately or go to Hospital – let them know that you suspect carbon monoxide poisoning.



Safety Information

⚠ Batteries (Where Present)

Batteries present a risk if they become damaged by the possible leaking of electrolyte. This electrolyte is an acid and can cause serious burn injuries. Care should be taken when working on or near them. **NOTE** the electrolyte may be in a liquid or gel form.

Should you come in to contact with electrolyte you should;

- Remove all clothing contaminated with electrolyte. If you cannot remove then saturate them in water.
- Get medical assistance as soon as possible.

You must advise the medical staff of the type of acid.

- Lead/acid battery = dilute sulphuric acid.
- Nickel/cadmium = potassium hydroxide alkali electrolyte.
- Use fresh running water to wash off excess electrolyte, continue this until medical assistance arrives. Make sure that you do not wash the electrolyte to another part of your body or face.
- If electrolyte comes in to contact with Eyes the electrolyte needs to be immediately washed away with large amounts of water. Make sure that you do not wash the electrolyte to another part of your face or body.
- Gasses from charging batteries are highly flammable and great care should be taken to charge in well ventilated areas.
-  There is an explosion risk if the battery terminals are short circuited, when connecting/disconnecting ALWAYS exercise great care so that the terminals or battery leads are NOT allowed to touch and cause a spark. ALWAYS use suitable insulated tools.



Safety Information

▲ Fuel Safety



CAUTION! ALL FUELS ARE HIGHLY FLAMMABLE AND PETROL VAPOUR IS EXPLOSIVE. TAKE EXTREME CARE WHEN HANDLING FUEL. KEEP FUEL OUT OF REACH OF CHILDREN.

General Safety

- Do not smoke each time fuel is handled.
- ALWAYS avoid inhaling fumes.
- ALWAYS carry fuel in the correct and clearly marked container.
- ALWAYS wear correct, suitable and fit for purpose Personal Protective Equipment (PPE), suggested items are but not limited to safety gloves and overalls.
- To avoid sparking or arcing, keep grounded conductive objects – such as tools – away from exposed, live electrical parts and connections. These events could ignite fumes or vapors.
- Do not operate the machine with known leaks in the fuel system.
- Fire hazard - keep fuel away from all sources of ignition for example heaters, lamps, sparks from grinding or welding.
- DO NOT carry out hot work on tanks that have contained fuel.
- ALWAYS keep the work area tidy.
- ALWAYS dispose of waste fuels correctly.
- Serious personal injury can occur when petrol is spilled on yourself or your clothes. Rinse your skin and change your clothes immediately.

Spilled Fuel

- If you have spilled fuel, make sure you do not attempt to ignite the engine but move the machine away from the area of spilled fuel and avoid creating any source of ignition until the fuel has evaporated and fuel vapours have dissipated.
- When fuel is spilled on yourself or your clothes, wash your skin and change clothes immediately.
- ALWAYS clean up spills promptly using absorbent granules and a lidded bin.



Safety Information

Fueling / De-Fueling

- ALWAYS fuel and de-fuel in a well ventilated area outside of buildings. Use a funnel to add fuel, only outdoors. Do not smoke during this and each time fuel is handled.
- Add fuel before igniting the engine, never remove the fuel tank cap or add fuel whilst the engine is running or when it is hot.
- When de-fueling ALWAYS use a proper fuel retriever.
- Never overfill the fuel tank. Engine heat can cause fuel to expand, never fill the tank to more than 1/2" below the bottom of the filler neck. This will provide space for fuel expansion.
- When refilling or draining the fuel tank, use an approved fuel storage container while in a clean, well-ventilated outdoor area. While adding fuel or operating the unit, do not smoke, and stay away from sparks, open flames, or other sources of ignition near the area of operation.
- Always stop the engine and allow it to cool before filling the fuel tank. Never remove the cap of the fuel tank or add fuel while the engine is running or when the engine is hot.
- Loosen the fuel tank cap slowly to relieve any pressure in the tank.
- ALWAYS keep the handles dry, clean and free of oil and fuel.
- After fueling, ensure to tighten the cap securely.
- Never use the lock-function when filling with fuel.
- Open the fuel tank slowly in order to allow any pressure which may have built up in the tank to dissipate. To prevent the risk of fire, move at least 3 metres away from the refuelling area before starting the appliance.

Storage

- Store fuel in containers specifically designed and approved for fuel storage.
- Store fuel in a cool, well-ventilated area, safely away from sparks, open flames, or other sources of ignition.
- Never store fuel – or a machine with fuel in the tank – inside a building where fumes may reach a spark, open flame, or any other source of ignition (such as a water heater, furnace, or clothes dryer). Allow the engine to cool before storing in any enclosure.
- Replace all fuel tank and container caps securely and wipe up spilled fuel. Never operate the unit without the fuel cap securely in place.



Safety Information

⚠ Electrical Safety (Where Applicable)



DANGER!

ELECTRICITY CAN KILL - NEVER WORK ON LIVE/ENERGISED EQUIPMENT.

- Prior to carrying out any maintenance work you **MUST** identify electrical isolation methods and isolate all electrical supplies.
- Prior to use and with all electrical supplies isolated, you **MUST** check all electrical cables, plugs and connectors for the following;
 - Are intact and have no signs of damage, to include but not limited to bare wires, chaffing, cuts and loose wiring.
 - If there are any signs of damage, the damaged item **MUST** be taken out of service until the damage has been repaired by an electrically competent person.
 - All trailing cables should be routed so as not to cause any kind of trip hazard.
 - **NEVER** work on or near electricity with wet hands, wet clothing and wet gloves.



Safety Information

⚠ Vibrations (Where Applicable)

- Prolonged use of hand held (operated) machines will cause the user to feel the effects of/from vibrations. These vibrations can lead to white finger (Raynaud's phenomenon) or carpal tunnel syndrome. This condition reduces the ability of the hand to feel and regulate temperature, causing numbness and heat sensations and may cause nerve damage and circulatory tissue death.
- Not all factors that lead to white finger disease are known, but cold weather, smoking and other diseases that affect blood vessels and blood circulation as well as large and long-lasting impact of shocks are considered factors in the formation of white finger. Note the following to reduce the risk of white finger and carpal tunnel syndrome;
- Wear gloves and keep your hands warm.
- Take regular breaks.
- All of the above precautions may help reduce the risk of white finger disease but not rule out the carpal tunnel syndrome. Long-term and regular users are therefore recommended to observe the condition of your hands and fingers. Seek medical attention immediately if any of the above symptoms should occur.

⚠ Noise (Where Applicable)

- The operating noise of the machine can damage your hearing. When wearing protection such as earplugs or ear defenders to protect your hearing. Long-term and regular users are advised to have hearing checked regularly. Be especially vigilant and cautious when wearing ear protection because your ability to hear alarm warnings will be reduced.
- Noise emissions for this equipment is unavoidable. Carry out noisy work at approved times and for certain periods. Limit the working time to a minimum. For your personal protection and protection of people working nearby it is also advisable for them to wear hearing protection.



- See Certificate of Conformity section for Outdoor Noise declaration of conformity.



Safety Information

⚠ Personal Protective Equipment

Appropriate Personal Protective Equipment (PPE), MUST be worn at all times when operating or repairing the machine. No protective equipment can ensure 100% protection.

When selecting PPE, make sure it's CE marked and it suits the user in terms of size, fit, etc. If more than one item of PPE is worn at the same time, make sure they can be used together, e.g. wearing safety glasses may disturb the seal of a respirator, causing air leaks.



HAND PROTECTION MUST BE WORN

Protective electrically non-conductive gloves are highly recommended when working.



FOOT PROTECTION MUST BE WORN

Non-skid heavy duty footwear are highly recommended when working.



HEARING PROTECTION MUST BE WORN

Suitable safety hearing protection is recommended.



EYE PROTECTION MUST BE WORN

Always wear safety glasses/goggles and/or face shields. Everyday eyeglasses have only impact resistant lenses; they are not safety glasses/goggles.



PROTECTIVE CLOTHING MUST BE WORN

Do not wear loose clothing, gloves, scarfs, neckties or jewellery (rings, wrist watches), which can be caught in moving parts.



HEAD PROTECTION MUST BE WORN

Wear a safety helmet with a safety visor.



FACE SHIELD MUST BE WORN

Wear a face shield to protect your face.



RESPIRATOR MUST BE WORN

Wear a respirator.



Safety Information

Intended Use

The HYMT5200X is a petrol powered multi-tool from HYUNDAI and is powered by a 52cc 2-stroke petrol engine.

The multi-tool is manufactured according to the latest safety requirements. Every precaution is only effective when it is followed exactly.

Intended Use:

Hedge trimmer - This appliance is intended for the cutting and trimming of hedges, bushes and flowering shrubs in the home environment. This is a hand-help appliance with an integrated engine unit with linear reciprocating cutting blades.

Pole Trimmer - This appliance is intended for trimming branches in trees.

Brush cutter - This appliance is for cutting high grass, undergrowth and light scrub.

Grass trimmer - This appliance is for cutting grass and small weeds.

User Types

This machine is intended for use by consumers, i.e. non professional operators. The machine is intended for "DIY" and domestic use only.

Improper Use















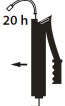

Any other usage not in keeping with the above mentioned ones may be hazardous and harm persons and/or damage things. Due to the physical risk posed to the user, the appliance may not be used to perform the following activities: cleaning footpaths and as a shredder for shredding tree and hedge sections. Furthermore, the appliance may not be used to level ground elevations such as molehills. For safety reasons, the appliance may not be used as a drive unit for any other devices. The user, not the manufacturer, is liable for any resulting damage or injuries of any kind.



Safety Information







Symbols On The Machine

We have provided safety messages in this manual and on the machine. This information alerts you to potential hazards that could hurt you or others. Please read these messages carefully. However, we may not have listed all of the possible hazards, you must also use your own judgment.

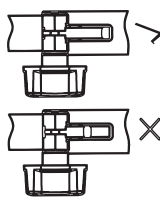
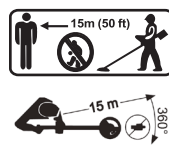
	WARNING You must read and understand all instructions before use.		WARNING Hot parts.
	WARNING Read the operating instructions before use.		SOUND Sound power level LWA data in dB.
	PPE Wear ear protection.		WARNING Fire, naked flames and smoking are prohibited.
	PPE Wear protective goggles.		IMPORTANT Add a little grease after every 20 hours of operation (gear grease).
	PPE Wear a hard hat.		CARBON MONOXIDE Never operate the engine indoor or in areas with low ventilation.
	PPE Wear protective goggles.		The exhaust gas from the engine contains carbon monoxide.
	PPE Wear safety shoes.		WARNING Do not use circular saw blades for the cutting blade function.
	IMPORTANT Keep a safe distance away.		WARNING Fire, naked flames and smoking are prohibited.
	WARNING Risk of injury due to running blades.		PRIMER Press the primer bulb.
	WARNING Falling objects, especially when cutting above head height.		WARNING Beware of flung objects.
	WARNING Protect the appliance from rain and moisture.		IMPORTANT Left hand thread.
	CAUTION Risk of injury from rotating cutting blade. Keep hands and feet away.		WARNING Beware of kickback!

Safety Information

Symbols On The Machine (Continued)

 <p>IMPORTANT</p> <ol style="list-style-type: none"> 1. Push the pin on the front boom into the groove on the engine unit boom as far as the stop. 2. Once it is correctly inserted, the red line must match up with the one on the engine unit boom. 3. If this is not possible, pull on the starter pull cord to adjust the shaft. <p>The On/Off switch must be set to "0".</p>	 <p>IMPORTANT</p> <p>A distance of 15m must be maintained between the machine and third parties.</p>
 <p>CE SYMBOL</p> <p>This product complies with the applicable European directives and an evaluation method of conformity for these directives was done.</p>	 <p>WARNING</p> <p>Risk of fatal electrical shock! Keep at least 10m away from overhead power lines.</p>
 <p>WARNING</p> <p>The cutting tool continues running after it is turned off (cutting blade/cutting filament)!</p>	 <p>WARNING</p> <p>Petrol is highly flammable! Explosion hazard! Do not spill fuel!</p>
 <p>WARNING</p> <p>Turn the appliance off and disconnect the spark plug before performing any maintenance work.</p>	

Features

HYMT5200X Features

*NOT TO SCALE

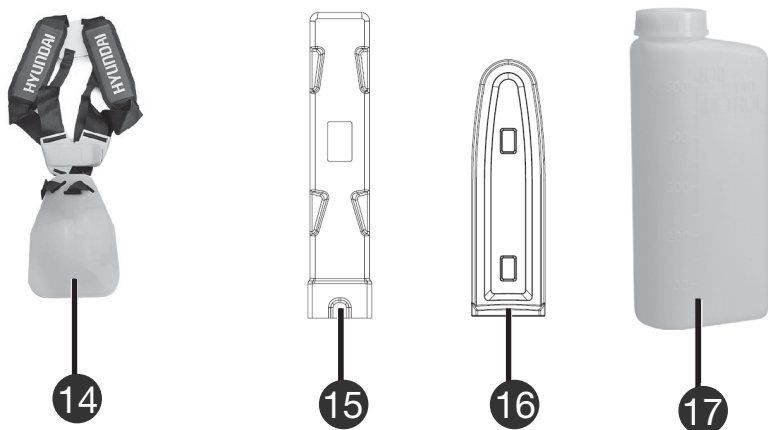
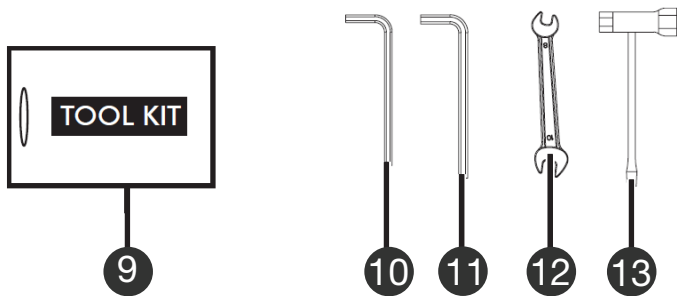
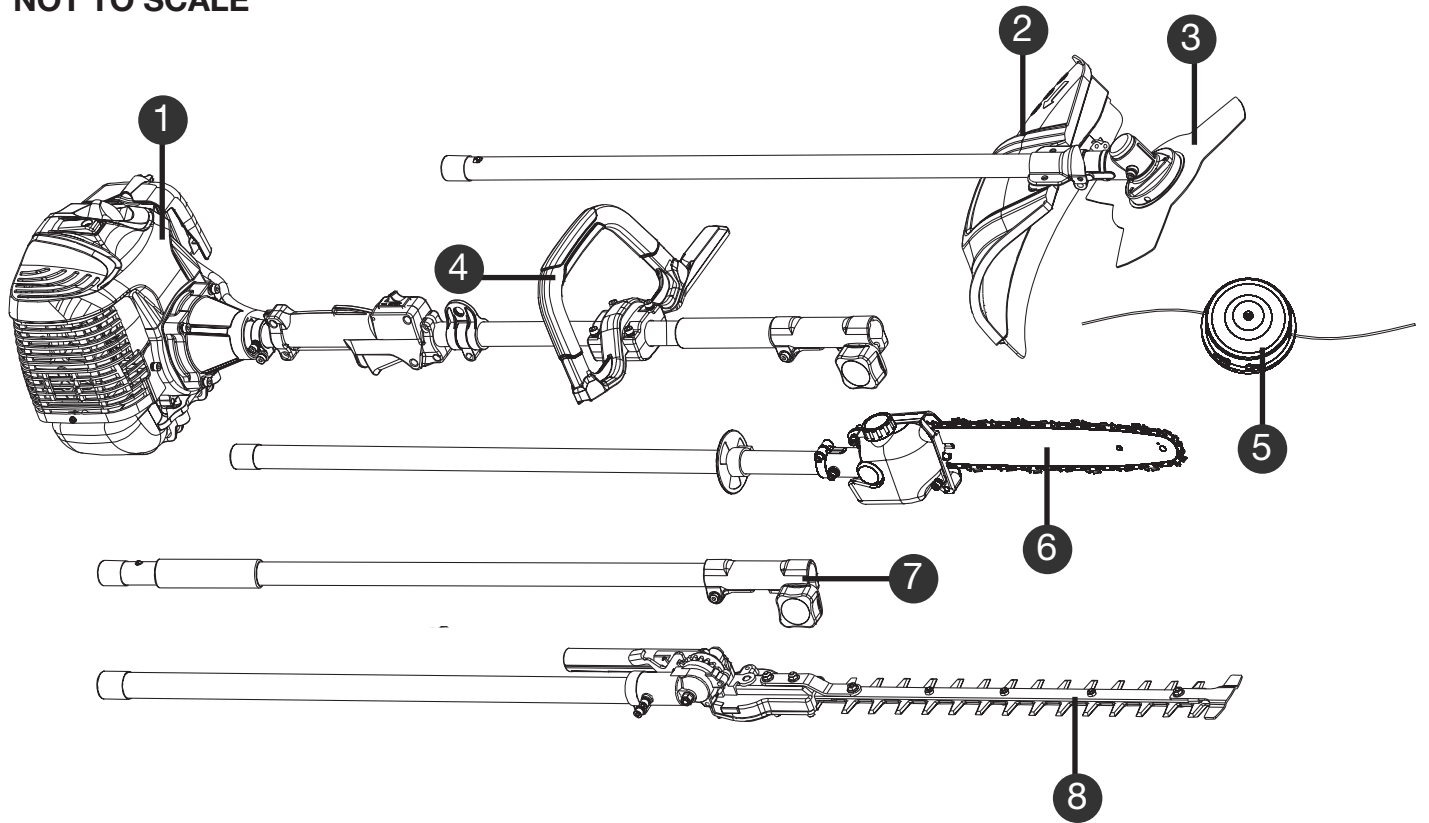

Features

HYMT5200X Features

- 1 Engine
- 2 Guard
- 3 Brush Cutter 3 Tooth Blade
- 4 Handle
- 5 Grass Trimmer Head
- 6 Pole Pruner
- 7 Extension Pole
- 8 Hedge Trimmer
- 9 Tool Kit
- 10 Hex Key 4mm
- 11 Hex Key 5mm
- 12 8mm/10mm Spanner
- 13 Spark Plug Box Spanner/Screwdriver
- 14 Harness
- 15 Hedge Trimmer Protector
- 16 Pole Pruner Protector
- 17 Mixing Bottle



Unboxing

⚠ Unboxing Safety

⚠ WARNING! Unboxing and assembling the machine should be done on a flat, stable surface with enough room. Disposal of the packaging should be done in accordance with the local regulations in force.

⚠ WARNING! Some of the packaging material may be harmful to children. Keep out of reach of children.

Carefully remove the product from the packaging and examine it for any sign of damage caused during shipping. Lay the contents out and check them. If any part is damaged or missing, you must not use the machine. Contact HYUNDAI Power Products immediately. You must keep the packaging material in case the machine needs to be returned or repaired.

Ensure that you have all the accessories and tools you need for assembly and operation including the suitable personal protective equipment.

Box Contents

- Engine Unit
- Hedge Trimmer Attachment
- Strimmer/Cutting Blade Attachment
- Pole Pruner Attachment
- Extension Pole
- Strimmer Guard
- Handle with Barrier Bar
- Tool Kit with 8mm/10mm Spanner, Spark Plug Box Spanner/Screwdriver, 4 & 5mm Hex Keys
- Oil/Petrol Mixing Container
- Carrying Harness
- Strimmer Line Head
- 3 Point Cutting Blade
- Pruner Chainsaw Bar and Cover
- Pruner Cutter Chain



Assembly

⚠ Assembly Safety

⚠ CAUTION - This guide is meant to serve as a quick reference for operating your HYUNDAI machine. We always advise reading the manual in full before operation.

⚠ CAUTION - For OUTDOOR use ONLY. Petrol machines produce carbon monoxide – poisonous, colourless and odourless gas that can cause serious injury or death. Petrol is highly flammable, always handle with extreme care and in a well ventilated area.

⚠ NOTE - Images may vary depending on model.

⚠ NOTE - The machine may be supplied with some parts already assembled. Prior to assembly, check all items have been received. The mulching plug may already be installed for transport.

⚠ NOTE - This machine is shipped without fuel and oil and MUST be filled before use. Failure to do so may cause damage to the engine that will not be covered by warranty.

We recommend that you fill out the information on page 58. If you need to contact an authorised dealer or customer service for information on servicing, you may need to provide this information.

There is also a service record so you can keep track of your machine service dates.



Assembly

Unboxing & Assembly Video:

Go to [youtube.com](https://www.youtube.com) and type in Hyundai HYMT5200X assembly.
YOU MUST read and understand the instruction manual first.

Step 1 : Engine Unit Handle

You will need 5mm hex key.

- 1 Remove four bolts from handle.
- 2 Put rubber bush around boom and line up the hole with a hole on the underside of boom. **See image 1.**
- 3 Place handle clamp over bush and insert peg on clamp into one of the holes. **See image 2.**
- 4 Place the handle on to the bottom clamp and evenly tighten the four hex bolts. **See image 3.**

Image 1

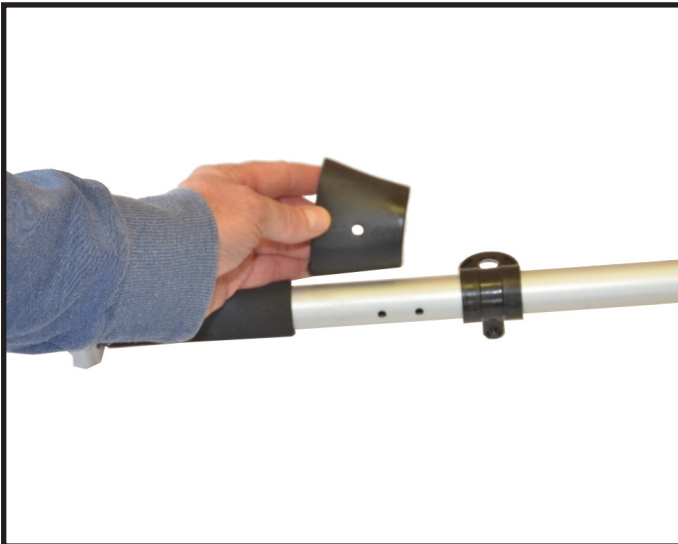

Image 2

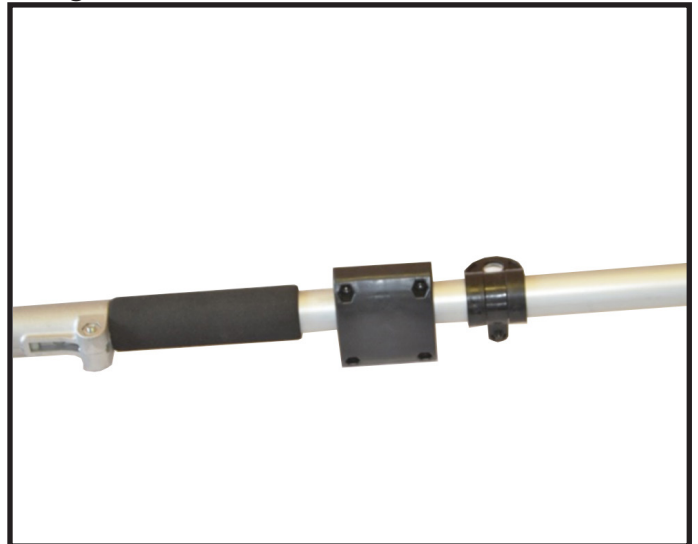
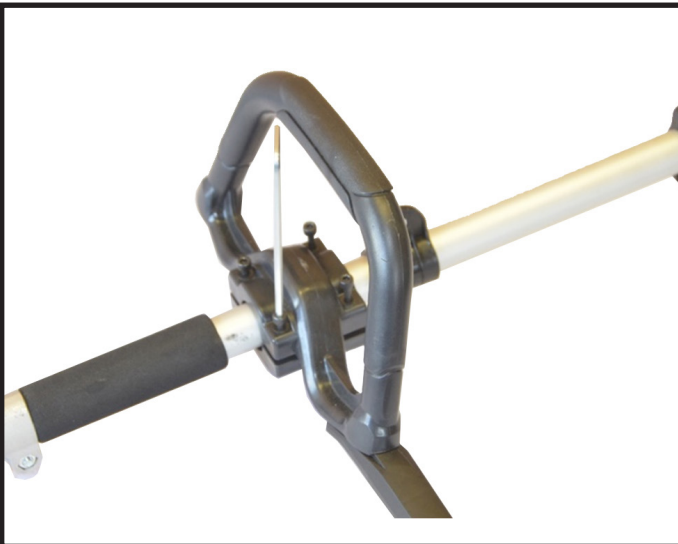

Image 3



Assembly

Step 2 : Harness

- 1 Attach harness using quick release mechanism. **See image 1.**
- 2 The black clamp can be loosened with 4mm hex key and adjusted back and forth to get the required balance of the machine.
- 3 The white buckle goes to the front of your body. **See image 2.**

Always use the harness when working with the machine. Turn the engine off before removing the harness.

Image 1



Image 2



Assembly

Grass Trimmer Attachment

You will need:

Grass trimmer shaft, plastic guard, filament line head, box spanner and hex key.

- 1 Attach Guard to Strimmer boom with two hex bolts.
- 2 To fit the grass trimmer head, insert hex key into hole on the side of head of the boom. This will lock the head and stop it turning when removing/tightening central bolt.
- 3 Turning clockwise (Left Hand Thread) Remove central bolt along with the 'doughnut' washer and thick 'boss' washer. Keep these washers safe. You will need them to fit the cutting blade.
- 4 Fit the strimmer line head by screwing it on anti-clockwise. Tighten firmly and then remove hex key from hole.

Image 1



Image 2

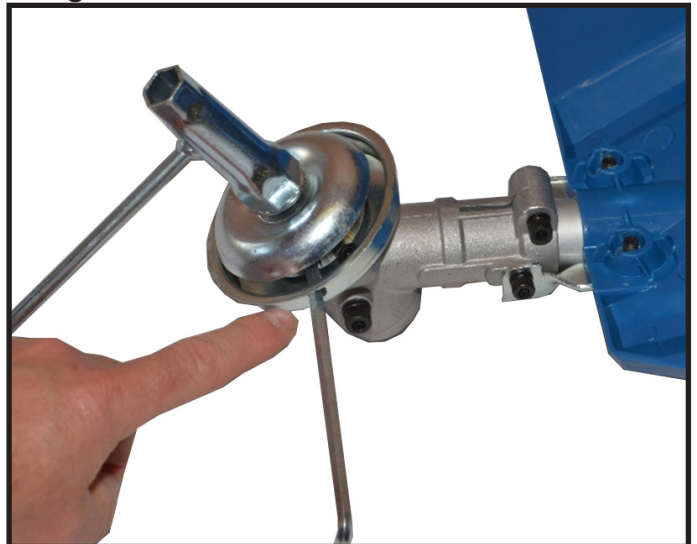
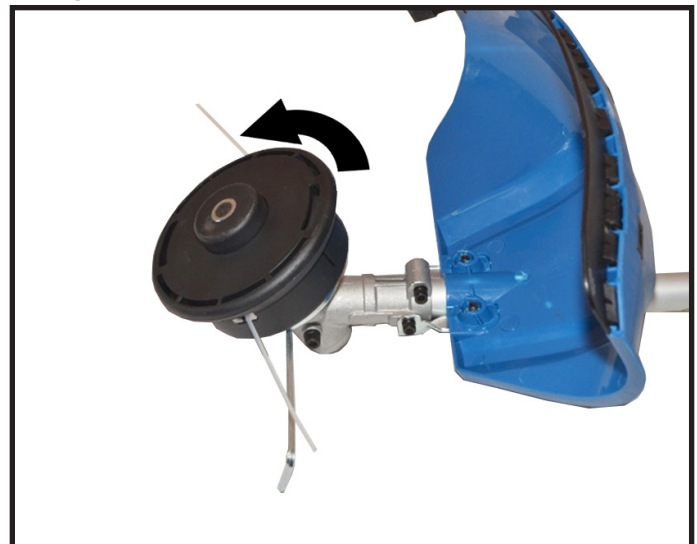

Image 3



Image 4



Assembly

Cutting Blade Attachment

- 1 Insert hex key into head locking hole. Unscrew strimmer head by turning clockwise.
- 2 First, place the cutting blade on the head with the writing facing down, towards the head. Make sure it sits centrally and securely on the head. **Extreme vibration will occur if it is not mounted correctly.** Then, fit the thick washer with the boss (bump) facing upwards away from head.
- 3 Next place 'doughnut' washer on as shown. Fit the nut and tighten firmly anti-clockwise. Remove hex key from locking hole. Remove plastic blade guard from around the blade.

CAUTION : Use extreme care whilst using this blade attachment. Especially around children and pets.

Image 1

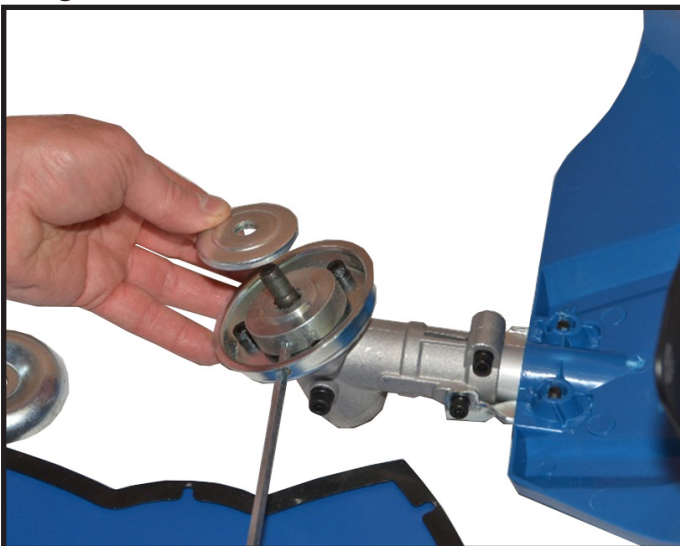

Image 2

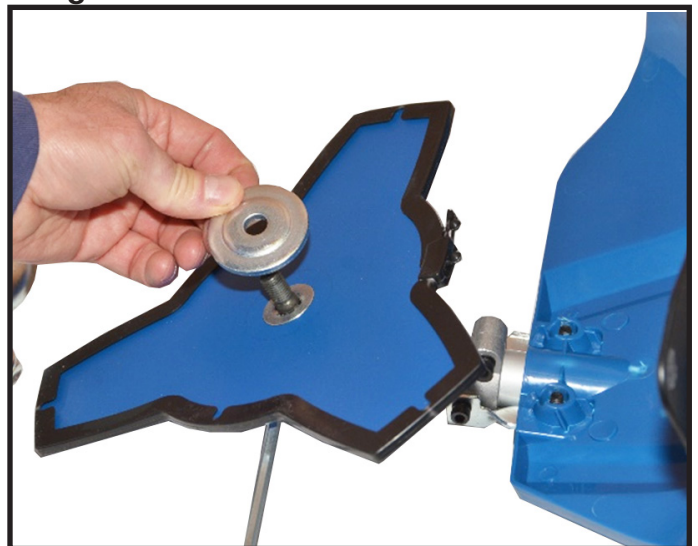
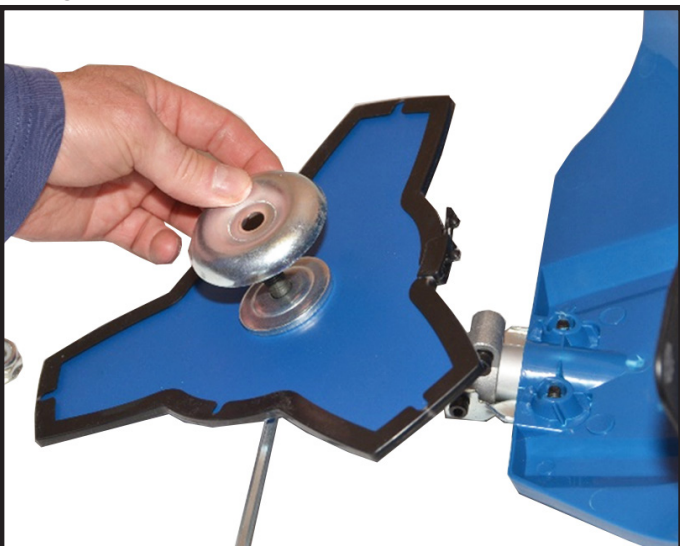

Image 3



Pole Saw Attachment

- 1 Using 10mm spanner, remove nut from the cover (anticlockwise).
- 2 Wearing thick gloves, fit the cutting chain over the drive sprocket, as shown.
- 3 Fit the bar and feed the inner teeth of the chain into the slot which runs around the bar. Make sure the adjustment peg sits in the hole on the bar as indicated.
- 4 Fit the cover back on, but make sure the adjustment peg stays located in the saw bar. Refit the nut and hand tighten only. (Clockwise)
- 5 Using flat bladed screw driver, turn the adjustment screw clockwise to tighten cutting chain tension.
- 6 Do not over tighten the chain. Using gloves, you should be able to pull the chain up about 5mm from bar. Carefully, pull the chain around the bar. It should move freely with no tight spots.
CAUTION: The teeth on the chain are very sharp. Wear thick gloves.
- 7 Finally, firmly tighten 10mm nut on the cover. Recheck the tension of the chain and adjust as necessary by loosening the 10mm nut and turning the adjustment screw.
- 8 We recommend you put environmentally friendly, organic chain oil in the oil tank before you use this attachment. Do not use old engine oil.

Image 1

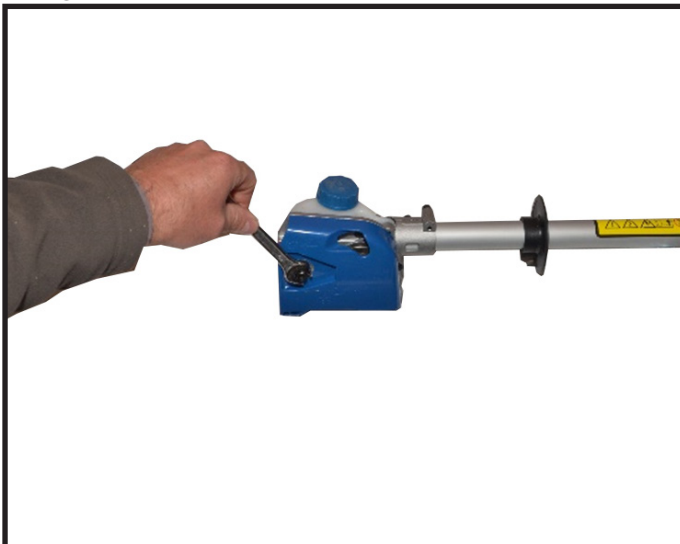
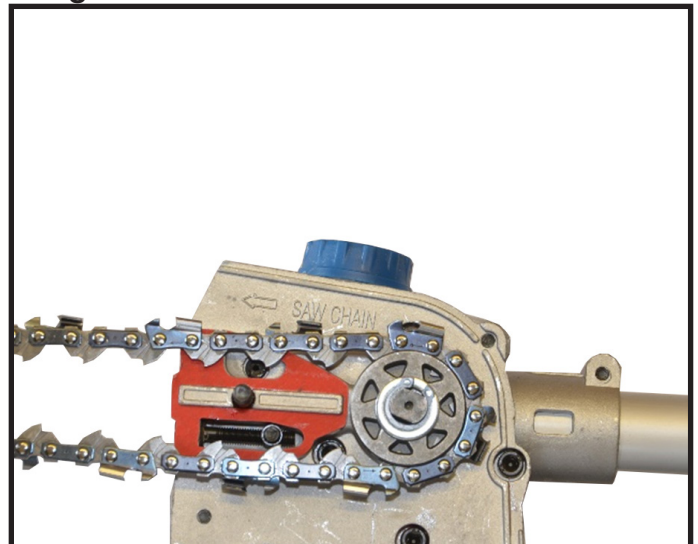

Image 2



Assembly

Image 3

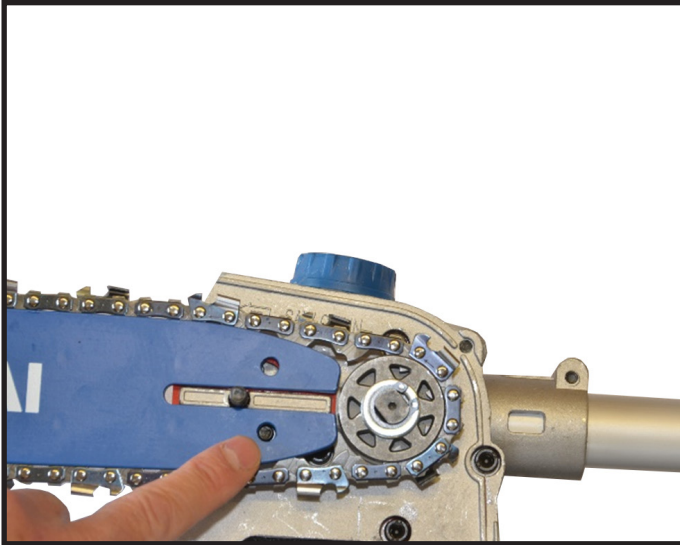

Image 4

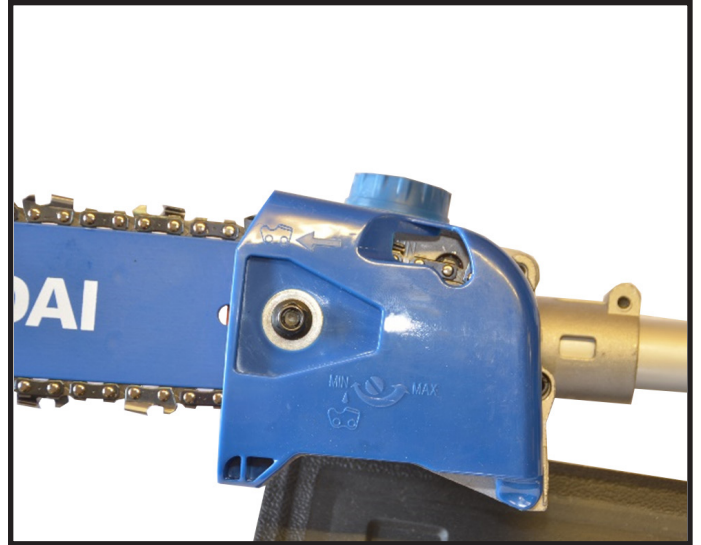

Image 5



Image 6



Image 7



Image 8



Preparation

Before Each Use

⚠ YOU MUST read and understand the full safety instruction manual before starting the machine.

⚠ CAUTION - For OUTDOOR use ONLY. Petrol machines produce carbon monoxide – poisonous, colourless and odourless gas that can cause serious injury or death. Petrol is highly flammable, always handle with extreme care and in a well ventilated area.

- 1 Always ensure that the machine is in a safe working condition. Inspect and check safety devices and guards and check all nuts, bolts and screws are secure.
- 2 Check the oil level and fill the fuel tank.
- 3 Make sure you know how to stop the machine and ensure you are familiar with emergency stop.
- 4 Start the machine following the instructions and stay clear of the machine's moving parts.



Preparation

Fuel And Oil

This is a 2-stroke engine and will need 2 stroke oil mixed with the unleaded petrol. The mix is 40 parts petrol to 1 part oil. (40:1). i.e. 1 litre of petrol requires 25ml of (semi-synthetic) 2 stroke oil.



CAUTION - Petrol is extremely flammable and must be mixed away from any naked flame or cigarette. Mixing petrol and oil must be done in a well ventilated area, preferably outside. Make sure you read the fuel safety before handling fuel.

- 1 Add the respective correct amounts of unleaded petrol and 2-stroke oil to the supplied oil/petrol mixing canister then shake the canister well.
- 2 Fill the petrol tank with fuel. Do not fill to the top of tank but leave at least 50mm from the top of cap.



Operation

Connecting Attachments To Motor Unit

- 1 Loosen off the blue hand screw.
- 2 Slide in attachment, it will only go in one way, so do not force it. Slide it in to the red line as shown.
- 3 Firmly tighten blue hand screw.

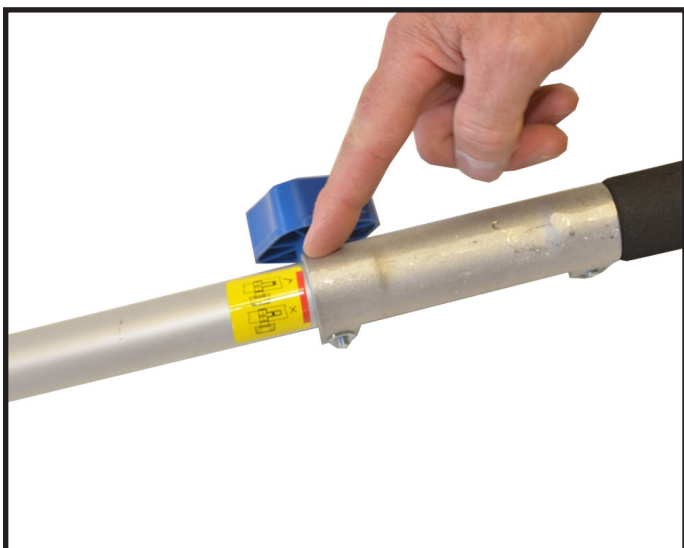

Connecting Extension Boom

- 1 The extension boom is attached between the motor unit and the tool being used to increase the height you can reach. Use the extra hand grips on the extension boom.

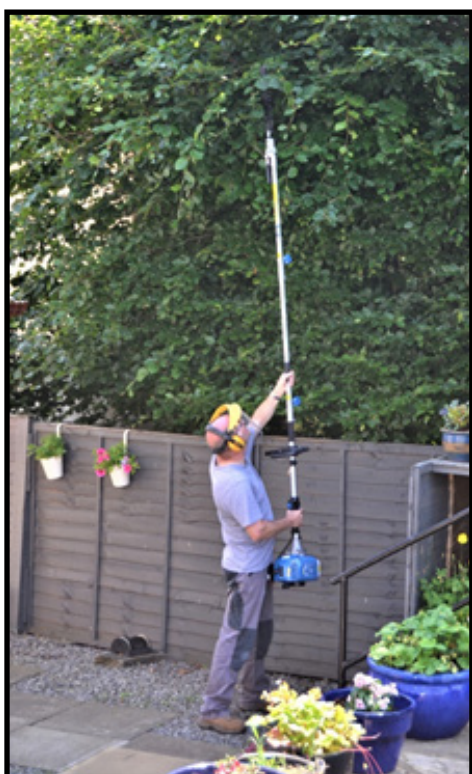

- 2 **CAUTION:** Be aware of overhead power/telephone wires.
- 3 Do not put undue pressure on the tool when using extension boom.
- 4 **CAUTION:** DO NOT use extension boom with the strimmer/blade attachment.



Operation

Using Grass Trimmer

- 1 To extend trimmer line from head, with the head spinning, simply bump the head down onto the ground and the line will automatically be fed out from the spool inside the head.
- 2 Do not press trimmer head hard onto the ground when trimming. This will prematurely wear out the head.
- 3 Always use the harness as shown.
- 4 Always use both hands to hold the machine.
- 5 Always eye and ear protection.
- 6 Be aware of your surroundings.
- 7 Do not use near children and pets.



Operation

Using The Pruning Saw

- 1 **CAUTION:** Use extreme care whilst using this attachment, especially around children and pets.
- 2 **CAUTION:** Be aware of overhead power/telephone wires
- 3 Always check the tension of the cutting chain before use.
- 4 This tool is only for pruning trees. Do not cut wood lying on the ground.
- 5 Hold the saw firmly in two hands and make sure you have secure footing.
- 6 Saw down onto the branch. If you saw upwards, underneath the branch you will probably trap the blade in the branch as it starts to fall.

⚠ CAUTION: Be aware of falling branches.

Preventing Kickback

- 1 Kick back happens when the tip of the blade catches in the wood you are cutting. This flicks up the blade and you may lose control. Never cut using the top part of the tip of the blade.
- 2 Do not use too much pressure on the tool.
- 3 Always replace the guard over the blade when you are finished.
- 4 Avoid any abnormal posture and do not saw over shoulder height. This will prevent inadvertent contact with the tip of the rail and allows a better control of the chainsaw in unexpected situations.
- 5 Always use the replacement rails and saw chains specified by the manufacturer. Incorrect replacement rails and saw chains can lead to a tearing of the saw chain and/or kickback.
- 6 Do not saw with the tip of the blade. This can lead to a kickback.
- 7 Ensure that there aren't any objects on the ground that you can trip over.

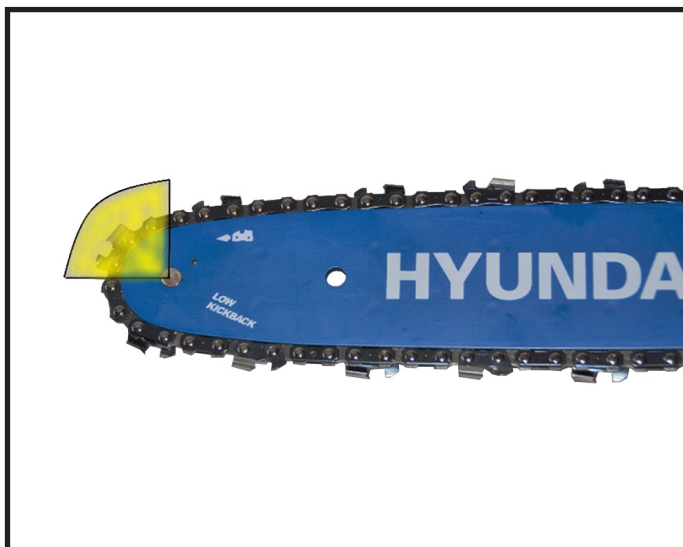

- 8 Hold the saw firmly with both hands, with your thumb and fingers around the handles. Position your body and arms so you can withstand kickback forces. If suitable measures are taken, the operator can control the recoil forces. Never let go of the chainsaw.
- 9 Do not rely solely on the chainsaw's built-in safety devices. As the user of a chainsaw, you can take a number of measures to avoid accidents and injury. A kickback is caused by incorrect use or misuse. It can be avoided by taking proper precautions

Operation

Using The Cutting Blade

- 1 **CAUTION:** Use extreme care when using this tool.
- 2 Always have a firm grip with two hands when using this attachment.
- 3 Keep children and pets 15m away when using.
- 4 The blade can fling stones and debris with great force. Always use face, leg and ear protection.
- 5 The blade can violently kick back if it comes into contact with hard objects.
- 6 The blade will keep spinning after the throttle has been released. Make sure the blade has stopped spinning before letting go of the machine.

Using The Hedge Trimmer

- 1 **CAUTION:** : Use extreme care whilst using this attachment, especially around children and pets.
- 2 Always use eye and ear protection
- 3 Always switch off the engine before performing any maintenance or adjustments to the cutting blades.
- 4 You can adjust the angle of the cutting blades by squeezing the two levers together near the joint.
- 5 Be careful of any fencing wire within your hedge.

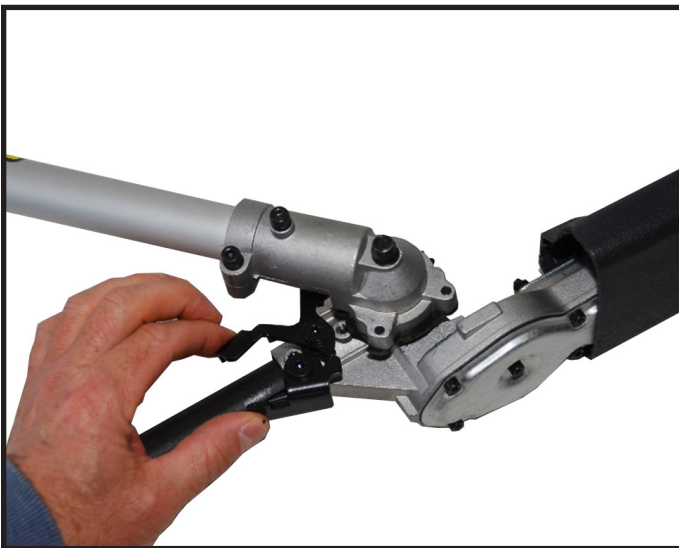

- 6 The double-sided cutter bar allows cutting in both directions or by using swinging movements from one side to the other.
- 7 For a vertical cut, move the hedge trimmer evenly forwards or up and down in an arc.
- 8 For a horizontal cut, move the hedge trimmer in a scything motion along the edge of the hedge so that cut branches fall to the ground.



Operation

Re-Filling Trimmer Line

- 1 Rotate the blue centre piece to align the arrow mark with the holes.
- 2 Check that the two holes are aligned.

Image 1



Image 2

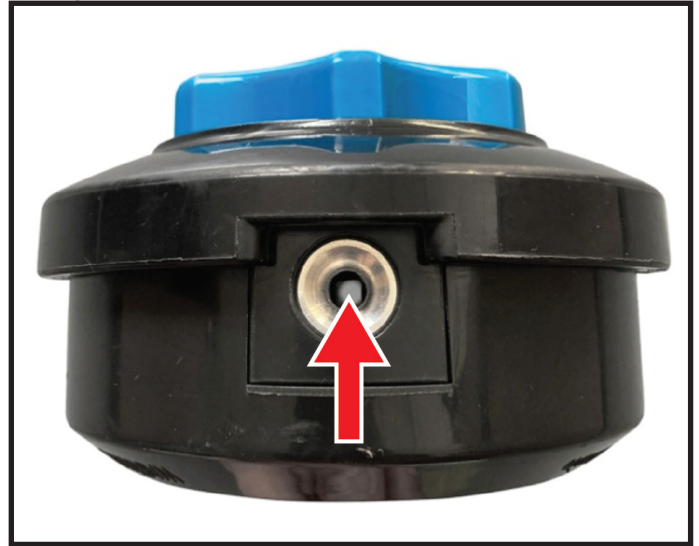

- 3 Pass the nylon rope through the two holes until you have 2m each side.
- 4 Use 4m of 2.4mm nylon trimmer line.

Image 3



Image 4



Operation

- 5 Turn the blue centre piece clockwise until there is 20cm of line remaining.

Image 5



Extending Trimmer Line

- 1 To extend trimmer line from head, with the head spinning, simply bump the head down onto the ground and the line will automatically be fed out from the spool inside the head.
- 2 Do not press trimmer head hard onto the ground when trimming. This will prematurely wear out the head.



Starting / Stopping

▲ NOTE - This machine is shipped without fuel and oil and **MUST** be filled before use. Failure to do so may cause damage to the engine that will not be covered by warranty.

Cold Start

- 1 Pump the primer bulb under the carburetor 6 times.
- 2 Slide the on/off switch back to (I).
- 3 Pull the red choke control out.
- 4 With your left hand holding down the engine, firmly pull the start cord with your right hand. Repeat until the engine starts.

CAUTION: Pull cord slightly away from the engine to avoid catching the Choke knob.

- 5 Leave for a few seconds and then press down the throttle lock out lever. You will then be able to pull up the throttle trigger. This will release the choke control and accelerate the speed of the engine.

Warm Start (the appliance has been turned off for less than 15-20 minutes)

- 1 Slide the On/Off switch back towards the engine. Place left hand on top of engine (Caution : engine may be hot). Pull the starter cord until engine starts. **See image 4.**

Stopping

▲ CAUTION - The engine and exhaust will remain hot for a while after use. Ensure the engine and exhaust has cooled before carrying out any maintenance, refuelling or storage.

- 1 Release the throttle. Slide the On/Off Switch away from engine



Starting / Stopping

Image 1



Image 2

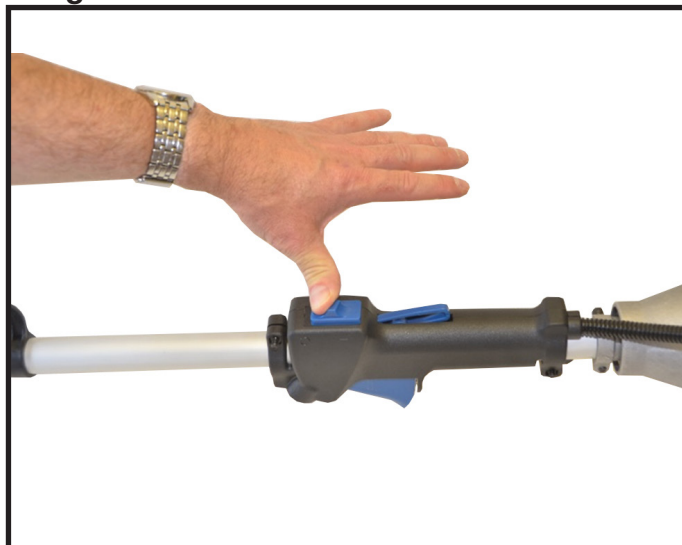

Image 3



Image 4



Image 5



Maintenance

⚠ Maintenance Safety

⚠ IMPORTANT - Routine and accurate maintenance is essential for maintaining original machine safety and performance levels.

⚠ WARNING - Before cleaning or doing maintenance work, you need to stop the engine, disconnect the spark plug cable and read the relevant instructions. You need to wear proper clothing and protective gloves whenever your hands are at risk.

⚠ If there are worn or damaged parts, never use the machine. Faulty or worn-out parts must be replaced and not repaired. You must only use original spare parts. The use of non-original and/or incorrectly fitted parts will jeopardize the safety of the machine. This may also cause accidents or personal injuries for which the manufacturer is under no circumstance liable or responsible.

⚠ Any maintenance operations or adjustments not explained in this manual must be carried out by your Dealer or a specialised Service Centre with the necessary knowledge and equipment to ensure that the work is done correctly maintaining the machine's original safety level. Any operations performed in unauthorised centres or by unqualified persons will invalidate the Warranty and all obligations and responsibilities of the Manufacturer.

⚠ Be very careful during adjustment of the machine to prevent entrapment of the fingers between moving parts and fixed parts of the machine.

Checking Your Machine

When checking your machine, we recommend you:

- Check for worn or damaged parts.
- Make sure all nuts, screws and bolts are tight.
- Make sure all warning stickers are in place and not damaged.
- Check for oil / fuel leaks.
- Check the oil and fuel levels regularly.
- All moving parts can move smoothly and freely.



Maintenance

Cleaning

 **CAUTION - DO NOT** use a hose pipe or pressure washer to clean the engine. Water can damage the engine or contaminate the fuel system.

 **NOTE** Engine must be switched off and spark plug lead disconnected.

General Cleaning

- You must remove grass and mud from the machine to prevent it from drying. This will cause problems the next time the machine is used.
- Wipe the machine down with a damp cloth.
- For larger build ups of debris, use a scraper or similar product.
- Dry the machine completely to prevent rust from forming.
- Make sure not to drip petrol onto the plastic parts to prevent damaging them and remove all traces of spilt petrol immediately. The warranty will not cover damage to plastic parts caused by petrol.
- Avoid using solvents when cleaning plastic parts. Most plastics are susceptible to damage from various types of commercial solvents and may be damaged by their use.

Cleaning The Pole Pruner

The pole pruner must be cleaned of sawdust at regular intervals.

- Remove the sprocket cover.
- Remove the saw chain from the blade and clean the guide rail.
- Dry the machine completely to prevent rust from forming.
- Keep the saw chain sharp and check the tension; check the oil level and the oil supply.

Cleaning The Hedge Trimmer







- Check the hedge trimmer for loose screws on the cutter bar and tighten these if necessary.
- Remove stuck cuttings.
- Maintain the cutter bar using an oil spray or an oil can.



Maintenance

Storage

Where To Store

-  Store in a cool, dry place away from sources of ignition and varying changes in temperature.
-  DO NOT stack other items on top of the machine when in storage. The protectors must be fitted for transport and storage
-  Store the machine in a safe place, out of the reach of children or anyone who is not familiar with operation.
-  To reduce fire hazards, keep the engine, silencer, and petrol storage area free of grass, leaves, or excessive grease. Do not leave containers full of cut grass inside storage areas.
-  DO NOT store the machine with fuel in the tank in an area where the fuel vapours could reach an open flame, a strong heat source or a spark.
-  DO NOT store a machine that has not been given time to fully cool down. Engine must be cooled down fully before storage.

Short Term Storage

After use, please follow the below steps before storing your machine.

- 1 Allow the engine to fully cool down.
- 2 Clean the machine. See the 'Cleaning' section.
- 3 Store the machine following the guidelines above.

Long Term Storage

If storing the machine for a period of 30 days or more, you must follow proper storage and winterisation guidelines to avoid any possible issues with the machine. Incorrect storage can lead to possible fueling or engine issues that will not be covered by the warranty.

- 1 Allow the engine to fully cool down.
- 2 Drain all the fuel from the fuel tank and then run the machine until it has completely run out of fuel to clear the remaining fuel from the fuel lines and carburettor.
- 3 Follow the cleaning instructions in the 'Cleaning' section.
- 4 Follow the maintenance section and check, service or replace serviceable items if required. Visually inspect the machine and replace or repair any worn parts. Check the blade and sharpen or replace if necessary.
- 5 Remove the spark plug. Add 1 teaspoon of 2-stroke oil to the combustion chamber. Pull the starter pull cord several times to wet all mechanical parts with oil. Replace the spark plug.



Maintenance

Preparation To Re-Use

- 1 Remove the spark plug.
- 2 Pull the starter pull cord quickly in order to remove any excess oil from the combustion chamber.
- 3 Clean the spark plug and observe the correct electrode gap on the spark plug.
- 4 Fill the fuel tank.

Transportation

Whenever the machine is to be handled, lifted, transported or tilted, you must:

- 1 Wear sturdy work gloves.
- 2 Hold the machine at the points that offer a safe grip, taking into account the weight and relative distribution of the same.
- 3 Use an appropriate number of people for the weight of the machine and the characteristics of the vehicle or the place where it must be placed or collected.
- 4 You must make sure that machine movements do not cause petrol leaks, damage or injuries.
- 5 During transport, make sure to fasten the machine securely with cables or straps.
- 6 Always use the protective cases and ensure that the machine cannot switch on during transport. Always carry the machine with the sharp parts facing away from your body.



Maintenance

Pole Saw Oil

- 1 You can adjust the amount of oil that is applied to the chain by turning this screw. It has 3 positions. The middle is the factory set position. Push and click anticlockwise for more oil. Push and click clockwise for less oil.
- 2 Check the oiling system is working by holding and running the saw blade close to a surface. Oil will be flung off the chain and on to the surface if it is working properly.

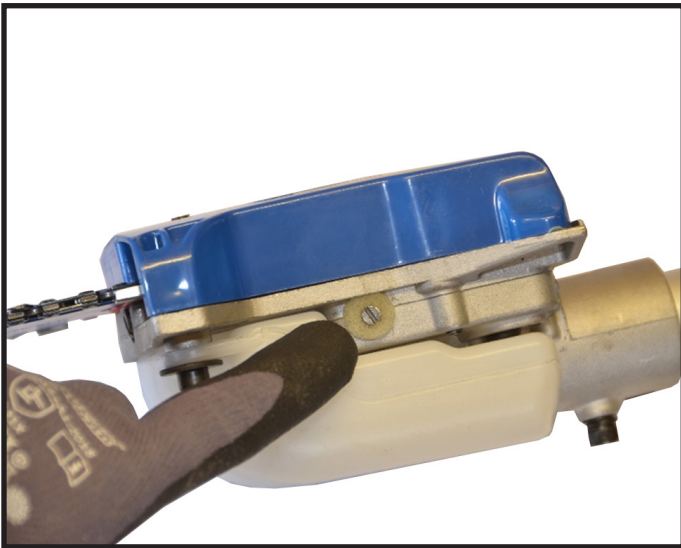

Pole Saw Chain Sharpening

- 1 You can sharpen the chain using the correct tool available at most garden machinery shops. The round file size is 3/8". Please follow the instructions that come with the tool.

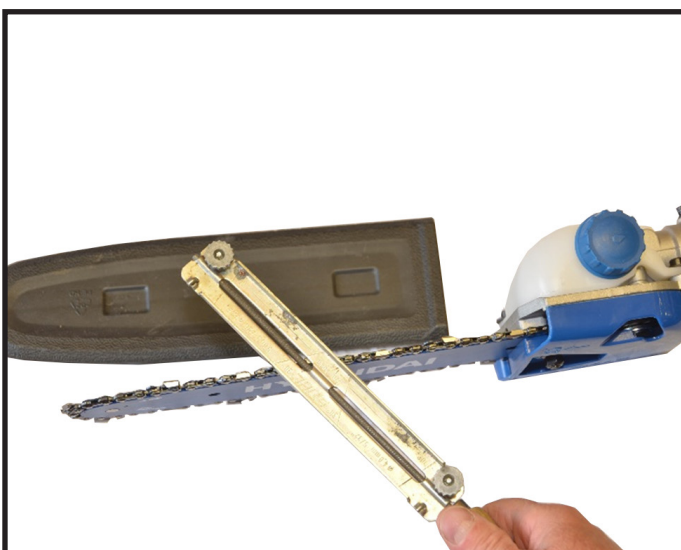

Air Filter

 **CAUTION** - A dirty air filter will restrict the air flow to the carburettor, which will reduce engine efficiency.

When using the machine in very dusty areas you must clean or replace the air filter more often. Never operate the machine without the air filter being fitted it can cause damage to the engine which is not covered by warranty.

- 1 Regular inspection is essential. The air filter must be inspected after every 25 hours of operation and cleaned if necessary.
- 2 Remove the cover of the air filter housing.
- 3 Remove the air filter.
- 4 Clean the air filter by tapping or blowing it out.
- 5 Assembly is done in the reverse order.



Maintenance

Spark Plug

For good performance, the spark plug must be properly gapped and free of deposits.

- 1 You **MUST** allow the engine to cool down before carrying out any maintenance.
- 2 Always use the correct spark plug.
- 3 Pull off the spark plug connector.
- 4 Remove the spark plug using the enclosed spark plug spanner.
- 5 Assembly is done in the reverse order.

Electrode gap = 0.6 mm (distance between the electrodes between which the ignition spark is generated). Check the spark plug for contamination after the first 10 hours of operation and clean it with a copper wire brush if required. Afterwards, service the spark plug after every 50 hours of operation.

Lubricating The Gears

- 1 Add liquid gear grease after every 20 hours of operation (approx. 10g) to lubricate the angle gear.
- 2 To do this, undo the screw to press the gear grease into the gear housing.
- 3 After filling the gearbox, close the lubrication hole with the screw.



Lubricating The Chain

- 1 Remove the oil filler cap.
- 2 Fill oil tank with organic chain oil.
- 3 The chain lubrication can be increased or decreased using the oil adjusting screw.
- 4 Press and then turn the oil adjusting screw clockwise to decrease the chain lubrication.
- 5 Press and then turn the oil adjusting screw anticlockwise to increase the chain lubrication.

 **WARNING-** Never work without lubricating the chain first. If the saw chain runs dry, the cutting equipment may become damaged within a short time. Always check chain lubrication before starting work.

Tightening And Checking The Saw Chain

 **WARNING-** Wear protective gloves. There is a danger of injury from the sharp cutting teeth. A new saw chain stretches and must be tightened more frequently.

- 1 First loosen the cover retaining nut to release the bar. Turn the chain-tensioner screw in a clockwise direction using the flat-blade screwdriver to increase the tension.
- 2 The saw chain must lie against the underside of the blade. Check whether the saw chain can be drawn over the blade by hand.
- 3 A new saw chain stretches and must be tightened more frequently.

Maintenance

The figures given here are based on normal operating conditions. In the event of more difficult conditions, such as strong dust generation and longer daily operating hours, the given intervals are to be reduced correspondingly.

Pole Pruner Maintenance Schedule

Appliance Part	Before Starting Work	Weekly	In The Event Of Faults	In The Event Of Damage	As Required
Lubricating The Chain	Check				
Check Saw Chain	1. Check The Sharpness 2. Check Chain Tension				Sharpen
Check Guide Rail	1. Check for wear/damage	1. Clean and turn 2. Deburr	Clean and turn	Replace	Replace
Check Sprocket		Replace			Replace

Hedge Trimmer Maintenance Schedule

Appliance Part	Before Starting Work	After Completion Of Work	As Required
Cutting blade	Visual inspection	Cleaning	Cleaning

▲ Where necessary, all corrective actions should be carried out by a suitably qualified person.



Troubleshooting

Engine Unit Troubleshooting

Problem	Possible Cause	Possible Solution
The engine does not start.	Incorrect start-up process.	Follow the instructions regarding starting.
The engine starts but does not run at full power.	1. Incorrect adjustment of the choke lever. 2. Contaminated air filter.	1. Set the choke lever to ↓ 2. Clean air filter.
The engine does not run smoothly.	Incorrect spark plug cap.	Clean the spark plug and adjust the spark plug gap or replace the spark plug.
Soot deposits or wetness on the spark plug.	Incorrect carburetor adjustment.	Adjust the carburetor. Contact aftersales.

Pole Pruner Troubleshooting

Problem	Possible Cause	Possible Solution
Motor is running, saw chain does not move.	Pole pruner attachment is not connected properly to the engine unit.	Check assembly.
Saw chain running slowly.	Saw chain dry/over-heating or is sagging.	Top up the oil or regrind, replace or tighten the saw chain.

Hedge Trimmer Troubleshooting

Problem	Possible Cause	Possible Solution
Motor is running, blades do not move.	Hedge trimmer attachment is not connected properly to the engine unit.	Check assembly.



Technical Data

Engine Specifications

Engine Type	2-Stroke Engine, Air-Cooled
Engine Output (Max.)	1.45kW / 2.0hp
Engine Size	51.7cc
Engine Idle Speed	3000rpm
Engine Speed (Max.)	With 3-Section Cutting Blade : 9200rpm With Grass Trimmer : 8700rpm With Chainsaw : 9200rpm With Hedge Trimmer : 9200rpm
Max. Cutting Speed	With 3-Section Cutting Blade : 6900rpm With Grass Trimmer : 6525rpm With Chainsaw : 20m/s With Hedge Trimmer : 1550rpm
Ignition	Electronic
Drive	Centrifugal Clutch
Weight (Power Unit Empty Tank)	Approx. 5.6kg
Fuel Tank Capacity	1200cm ³
Spark Plug	CDK L8RTC
Fuel Consumption At Max. Engine Performance	0.6kg/h
Specific Fuel Consumption At Max. Engine Performance	446g/kWh

Hedge Trimmer Specifications

Cut Length	425mm
Tooth Spacing	20mm

Pole Pruner Specifications

Oil Tank Recommended Fill Level	140cm ³
Cut Length	Approx. 260mm
Blade	10 inch
Saw Chain	10 inch



Technical Data

Brush Cutter Specifications

Metal Blade Cutting Diameter	255mm
------------------------------	-------

Grass Trimmer Specifications

Nylon Line Cutting Circle	430mm
Nylon Line Length	4m
Nylon Line Diameter	2.4mm

Noise Information

	Hedge Trimmer	Pole Pruner	Brush Cutter	Grass Trimmer
Sound Pressure Level LpA	99.47dB(A)	99.5	93.24	94.74
Uncertainty KWA	2.5dB	2.5	2.5	2.5
Sound Power Level LWA	110.05dB(A)	111.54	105.52	105.62
Guaranteed Sound Power Level LWA	114dB(A)			
Uncertainty KWA	2.5dB	2.5	2.5	2.5

Vibration Information

	Hedge Trimmer	Pole Pruner	Brush Cutter	Grass Trimmer
Vibration On Front Handle	Vibration Emission Value $a_{h,D} = 5.165\text{m/s}^2$ Uncertainty K = 1.5m/s^2	Vibration Emission Value $a_{h,D} = 7.41\text{m/s}^2$ Uncertainty K = 1.5m/s^2	Vibration Emission Value $a_{h,D} = 7.6\text{m/s}^2$ Uncertainty K = 1.5m/s^2	Vibration Emission Value $a_{h,D} = 7.09\text{m/s}^2$ Uncertainty K = 1.5m/s^2
Vibration On Rear Handle	Vibration Emission Value $a_{h,D} = 8.95\text{m/s}^2$ Uncertainty K = 1.5m/s^2	Vibration Emission Value $a_{h,D} = 7.993\text{m/s}^2$ Uncertainty K = 1.5m/s^2	Vibration Emission Value $a_{h,D} = 9.79\text{m/s}^2$ Uncertainty K = 1.5m/s^2	Vibration Emission Value $a_{h,D} = 12.85\text{m/s}^2$ Uncertainty K = 1.5m/s^2

The vibration level varies in accordance with use and may be higher than the value specified in these instructions in some cases. There is a risk of underestimation of the vibration load if the appliance is used regularly in this manner. To estimate the vibration load during a specific working period accurately, periods during which the appliance is switched off (or running, but not being used) must also be taken into account. This can significantly reduce the vibration load over the total working period.

Recycling And Disposal

Recycling And Disposal



We do not offer a takeback scheme for the recovery of Waste Electrical Electronic Equipment (WEEE) & Batteries. Instead the responsibility to dispose of WEEE and/or Batteries is passed onto you by us.

So when it becomes necessary to dispose of your machine you must take it to your local Civic Amenity Site. For further information please contact your local Authority for disposal advice.

You **MUST** make sure that all unused oil and fuel is disposed of correctly either beforehand or at your local Civic Amenity Site.

- Under NO circumstances must any fuel or oil be put down any drains.
- Certain products contain WEEE waste which should not be disposed of in your domestic waste.
- You **MUST** recycle WEEE in accordance with your local authority or recycling centre.
- Certain products contain batteries which should not be disposed of in your domestic waste.
- You **MUST** recycle batteries in accordance with your local authority or recycling centre.
- Unwanted packaging and materials should be stored and taken to a recycling centre so it can be disposed of in a manner which is compatible with the environment.

We are a Member of the VALPAK National Compliance Scheme and our registration number is **RM08660**. For further information about disposal please contact your Local Authority.

You can also get more advice and guidance about recycling at the following website
<http://www.recycle-more.co.uk>

Should you pass this product on to another user either sold or loaned, you **MUST** pass on this user manual. This will make sure that all other users can use and maintain this machine safely.

Environmental Protection

1. Environmental protection should be a priority of considerable importance when using the machine, for the benefit of both social coexistence and the environment in which we live. Try not to cause any disturbance to the surrounding area.
2. You must comply with local regulations and provisions for the disposal of packaging, oils, petrol, filters, damaged parts or any elements which have a strong impact on the environment. This waste must not be disposed of as normal waste. It needs to be separated and taken to specified waste disposal centres where the material will be recycled.
3. You must comply with local regulations for the disposal of waste materials after mowing.
4. When disposing, do not pollute the environment with the machine, but hand it over to a disposal centre, in accordance with the local laws in force.



Declaration Of Conformity

EC Declaration of Conformity

We hereby declare that the machine detailed in this declaration complies to all the relevant provisions of the following EC directives.

- 2006/42/EC The Machinery Directive
- 2014/30/EU Annex II Electromagnetic Compatibility Directive
- 2016/1628/EC The Emission of Gaseous and Particulate Pollutants from internal Combustion engines
- 2000/14/EC Noise Emissions in the Environment by Equipment for use Outdoors

And is in conformity with the applicable requirements of the following documents:

- EN ISO 11806-1:2011
- EN ISO 10517:2019

Declaration for 2000/14/EC Noise Emissions in the Environment by Equipment for use Outdoors.
Notified Body for EC Directive 2000/14/EC TÜV Rheinland (Shanghai) Co., Ltd.

Model	Type	Engine Size	Measured Sound Power	Guaranteed Sound Power	Engine Output
HYMT5200X	Multi-tool	51.7cc	99dB(A)	112dB(A)	1.45kW

Product Details:

Brand: Hyundai
Model: HYMT5200X
Description: Petrol Multi-Tool

Name and address of technical documentation holder and EU distributor:

Genpower Ltd, Isaac Way, Pembroke Dock, Pembrokeshire, SA72 4RW, UK.

Signed by:  Roland Llewellyn, Managing Director

Date: 16/12/2020



Useful Information

Check Out Our YouTube Channel

Our videos on YouTube include:

- Unboxing
- Assembly of your machine
- How to service your machine
- Products in use
- 'How To' videos
- Product features

Go to www.hyundaisupport.co.uk or search 'Hyundai Power Products' in YouTube.

Warranty

Proof of purchase will be required before you make a warranty claim.

Full warranty terms and conditions can be found on the HYUNDAI POWER PRODUCTS website: www.hyundaipowerproducts.co.uk

Manual Updates

Our manuals are constantly being reviewed and updated. Should you find an error, omission or something unclear, please contact us for assistance.

We reserve the right to make any modifications without prior notice whenever necessary.

Our latest manuals are also placed online.

All our manuals can be downloaded at: www.hyundaipowerproducts.co.uk

Returning Your Product

If you are returning your product, please contact the dealer for their returns policy.

Leaving A Review

We work very hard to give all of our customers the best possible service. If you have any problems, before leaving negative feedback, please contact us to give us a chance to resolve the issue. We would be delighted if you left us positive feedback!

To leave a review, please go to: uk.trustpilot.com/review/hyundaipowerequipment.co.uk

Ordering Spare Parts

Only use original spare parts: The use of non-original and/or incorrectly fitted parts will jeopardize the safety of the machine, may cause accidents or personal injuries for which the Manufacturer is under no circumstance liable or responsible.



Our Product Range

Generators

Leisure Inverter, Petrol, Diesel And Built-In Motorhome Generators

Pressure Washers

Petrol, Diesel And Electric Pressure Washers

Water Pumps

Submersible, Clean And Dirty Water And Professional Chemical Water Pumps

Lawnmowers

Petrol, Cordless, Electric, Roller, Self Propelled, Electric Start And Robotic Lawnmowers

Grass Trimmers And Brush Cutters

Petrol, Cordless, Electric And Wheeled Grass Trimmers And Brush Cutters

Chainsaws

Petrol, Cordless And Electric Chainsaws

Hedge Trimmers

Petrol And Cordless Hedge Trimmers

Leaf Blowers

Petrol, Electric, Cordless, Backpack And 3 -in-1 Leaf Blowers

Log Splitters

Horizontal, Vertical, Petrol And Electric Log Splitters

Wood Chippers

Petrol And Electric Start Wood Chippers

Tillers

Petrol Garden Tiller And Cultivator

Earth Augers And Trenchers

Petrol Earth Augers And Heavy Duty Trenchers

Compactor Plates

Petrol Compactor Plates

Cement Mixers

Portable Electric Cement Mixers

Mini Dumpers

4-Wheel Drive Mini Dumpers And Tracked Dumpers

Yard Sweeper

Self Propelled Yard Sweeper Power Brush

Scarifiers

Petrol Lawn Scarifier And Aerator

Stump Grinders

Petrol 4-Stroke Stump Grinders

Welders And Plasma Cutters

MIG, TIG, MMA, ARC Welders And Plasma Cutters

Power Tools And Tool Chests

Electric And Cordless Power Tools And Filled Tool Chests

Vacuum Cleaners

Wet And Dry Vacuum Cleaners

Engines

Petrol And Electric Start Engines

Battery Chargers / Starters

6V, 12V, 24V Battery Chargers, Jump Starters And Hydraulic Floor Jack

Air Compressors

Home, Domestic, DIY And Professional Use Air Compressors

Lighting Towers

Mobile Lighting Towers With Diesel Generators

Portable Power Stations

Camping Power Packs And Solar Chargers

And More

We Are Constantly Expanding Our Range With New Products

If you would like more information on any of these products, please contact our sales team on 01646 687880 or visit our website www.hyundaipowerproducts.co.uk



Product Information

Information

As soon as you have purchased the machine, we recommend that you fill out the following. If you need to contact an authorised dealer or customer service for information on servicing, you may need to provide the following information.

The model number and serial number can be found on the grey specification sticker on your machine.

Date Of Purchase:

Dealer Name:.....

Dealer Phone:.....

Model Number:.....

Serial Number:.....

Service Record

1st Service

Date Of Service.....

Next Service Due.....

2nd Service

Date Of Service.....

Next Service Due.....

3rd Service

Date Of Service.....

Next Service Due.....

4th Service

Date Of Service.....

Next Service Due.....



Need Help? Talk To Our Experts

Contact Us

Our friendly aftersales team will be more than happy to help you.



Phone

Call our team on 01646 687880, open Monday-Friday 8.30am-5pm.



Email

aftersales@hyundaipowerproducts.co.uk



Online Live Chat

Go to www.hyundaipowerproducts.co.uk

Live chat is open Monday-Friday from 8.30am-5pm.



Post

Genpower Limited, Isaac Way, Pembroke Dock, Pembrokeshire, SA72 4RW, UK.



HYUNDAI

POWER PRODUCTS

Importer:
GENPOWER LTD
Isaac Way, London Road,
Pembroke Dock, UNITED KINGDOM, SA72 4RW
T: +44 (0) 1646 687 880 F: +44 (0) 1646 686 198
E: info@hyundaipowerproducts.co.uk
www.hyundaipowerproducts.co.uk

Imported/Distributed by Genpower Ltd for The United Kingdom & Ireland

Licensed by Hyundai Corporation, Korea