

HSA 26

STIHL



2 - 23 Instruction Manual



Contents

1	Introduction.....	2
2	Guide to Using this Manual.....	2
3	Overview.....	3
4	Safety Precautions.....	4
5	Preparing Shrub Shears for Operation.....	11
6	Charging the Battery, LEDs.....	11
7	Assembling the Shrub Shears.....	12
8	Removing and Fitting the Battery.....	12
9	Switching the Shrub Shears On/Off.....	13
10	Checking the Shrub Shears and Battery.....	13
11	Operating the Shrub Shears.....	13
12	After Finishing Work.....	14
13	Transporting.....	14
14	Storing.....	15
15	Cleaning.....	15
16	Maintenance.....	16
17	Repairing.....	16
18	Troubleshooting.....	17
19	Specifications.....	18
20	Spare Parts and Accessories.....	19
21	Disposal.....	19
22	EC Declaration of Conformity.....	19
23	UKCA Declaration of Conformity.....	20
24	Addresses.....	20
25	General Power Tool Safety Warnings.....	20

1 Introduction

Dear Customer,

Thank you for choosing STIHL. We develop and manufacture our quality products to meet our customers' requirements. The products are designed for reliability even under extreme conditions.

STIHL also stands for premium service quality. Our dealers guarantee competent advice and instruction as well as comprehensive service support.

STIHL expressly commit themselves to a sustainable and responsible handling of natural resources. This user manual is intended to help you use your STIHL product safely and in an environmentally friendly manner over a long service life.

We thank you for your confidence in us and hope you will enjoy working with your STIHL product.



Dr. Nikolas Stihl

IMPORTANT! READ BEFORE USING AND KEEP IN A SAFE PLACE FOR REFERENCE.

2 Guide to Using this Manual

2.1 Applicable Documentation

Local safety regulations apply.

- ▶ Read, understand and save the following documents in addition to this instruction manual:
 - Safety information for STIHL batteries and products with built in batteries:
www.stihl.com/safety-data-sheets

2.2 Warning Notices in Text



DANGER

- This notice refers to risks which result in serious or fatal injury.
 - ▶ Serious or fatal injuries can be avoided by taking the precautions mentioned.



WARNING

- This notice refers to risks which **can** result in serious or fatal injury.
 - ▶ Serious or fatal injuries can be avoided by taking the precautions mentioned.

NOTICE

- This notice refers to risks which can result in damage to property.
 - ▶ Damage to property can be avoided by taking the precautions mentioned.

2.3 Symbols in Text



This symbol refers to a chapter in this instruction manual.

3 Overview

3.1 Shrub Shears, Battery and Charger

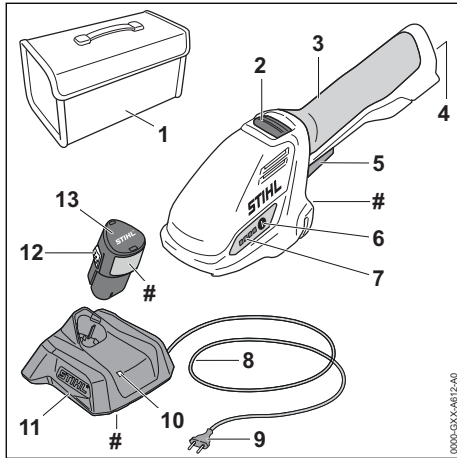

- 1 Bag**
For transporting and storing the shrub shears, battery and charger. The bag only comes with the set (consisting of shrub shears, battery and charger).
- 2 Release Slide**
Unlocks the trigger.
- 3 Control Handle**
For operating, holding and controlling the shrub shears.
- 4 Battery Compartment**
Accommodates the battery.
- 5 Trigger**
The trigger switches the shrub shears on and off.
- 6 Button**
Activates the LEDs on the shrub shears.
- 7 LEDs**
Indicate battery's state of charge and malfunctions.
- 8 Connecting Cable**
Connects charger to appliance plug.
- 9 Appliance Plug**
Connects cable to wall outlet.
- 10 LED**
The LED indicates the operating status of the charger.
- 11 Charger**
Charges the battery.

12 Locking Hook

Holds the battery in the battery compartment.

13 Battery

Supplies power to the shrub shears.

Rating Label with Serial Number

3.2 Shrub Shear Blade and Grass Shear Blade

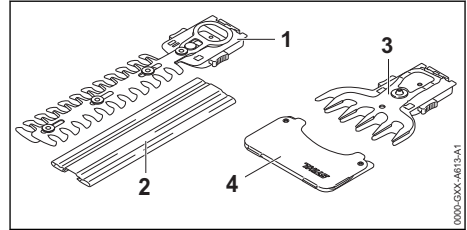

1 Shrub shear blade, cutting blades

The cutting blades cut shrubs.

2 Blade Scabbard

Helps protect user from contact with the shrub shear blade.

3 Grass shear blade, cutting blades

The cutting blades cut grass.

4 Blade Scabbard

Helps protect user from contact with the grass shear blade.

3.3 Symbols

Meanings of symbols that may be on the shrub shears, battery and charger:



The LED glows or flashes green. Battery is being charged.



LED flashes red. No electrical contact between battery and charger or malfunction in battery or charger.



L_{WA} Guaranteed sound power level according to directive 2000/14/EC in dB(A) in order to make sound emissions of products comparable.



The data next to this symbol indicates the energy content of the battery according to the cell manufacturer's specification. The energy content available during operation is lower.



Operate the electric product in a dry place, indoors only.



Do not dispose of the product with your household waste.



Read, understand and save the instruction manual.

4 Safety Precautions

4.1 Warning Signs

4.1.1 Shrub shears

Meanings of warning signs on the shrub shears:



Observe safety notices and take the necessary precautions.



Read and understand the User Manual and keep it in a safe place for reference.



Wear safety glasses.



Do not touch trailing cutting blades.



Do not touch moving cutting blades.



Comply with safety notices concerning ejected objects and take the necessary precautions.



Maintain a safe distance.



Protect the shrub shears against rain and dampness.



Remove the battery during work interruptions, transport, storage, maintenance or repair.

4.1.2 Battery

Meaning of warning symbols on the battery:



Observe safety notices and take the necessary precautions.



Read and understand the User Manual and keep it in a safe place for reference.



Protect the battery against heat and fire.



Do not immerse the battery in liquids.

4.1.3 Charger

Meanings of the warning signs on the charger:



Observe safety notices and take the necessary precautions.



Read and understand the User Manual and keep it in a safe place for reference.



Protect the charger from rain and dampness.

4.2 Intended Use

The STIHL HSA 26 shrub shears are designed for the following applications:

- With a shrub shear blade: Cutting shrubs
- With a grass shear blade: Cutting grass

Do not use the shrub shears in the rain.

The STIHL AS battery supplies power to the shrub shears.

The STIHL AL 1 charger recharges the STIHL AS battery.

▲ WARNING

- Batteries and chargers not approved for the shrub shears by STIHL may cause a fire or explosion. Persons may be seriously or fatally injured, and property may be damaged.
 - ▶ Use the shrub shears with a STIHL AS battery.
 - ▶ Recharge the STIHL AS battery with a STIHL AL 1 charger.
- Using the shrub shears, battery or the charger for purposes for which they were not designed may result in serious or fatal injuries, and damage to property may occur.
 - ▶ Use the shrub shears, battery and charger as described in this User Manual.

4.3 Requirements for the user

▲ WARNING

- Users without adequate instruction cannot recognize or assess the risks involved in using the shrub shears, battery and charger. The user or other persons may sustain serious or fatal injuries.



- ▶ Read and understand the User Manual and keep it in a safe place for reference.
- ▶ If you pass on the shrub shears, battery and charger to another person: Always give them the User Manual.
- ▶ Make sure that the user meets the following conditions:
 - The user is rested.
 - The user must be in good physical, sensory and mental health to operate and work with the shrub shears, battery and charger. If the user is able to operate the equipment but is physically, sensory or mentally impaired, the user may only work with the equipment under the supervision of or after receiving instruction from a responsible person.
 - The user is able to recognize and assess the risks involved in using the shrub shears, battery and charger.
 - The user is an adult or is being trained in an occupation under supervision according to national regulations.
 - The user has received instruction from a STIHL authorized dealer or other experienced user before working with the shrub shears and using the charger for the first time.
 - The user is not under the influence of alcohol, medication or drugs.
- ▶ If you are unsure: Contact a STIHL authorized dealer.
- ▶ If dust is generated: Wear a dust respirator mask.
- Inappropriate clothing can snag on wood, brush or the shrub shears. Not wearing suitable clothing may result in serious injury.
 - ▶ Wear close-fitting clothing.
 - ▶ Remove scarves and jewelry.
- The user may come into contact with the moving cutting blades while working. This may result in serious injury to the user.
 - ▶ Wear robust footwear.
 - ▶ Wear long trousers made from resistant material.
- The user may come into contact with the cutting blades during cleaning or servicing. This may result in injury to the user.
 - ▶ Wear work gloves made from resistant material.
- Wearing unsuitable footwear may cause the user to slip. This may result in injury to the user.
 - ▶ Wear sturdy, closed-toed footwear with high-grip soles.

4.5 Work Area and Surroundings

4.5.1 Shrub Shears

▲ WARNING

- Bystanders, children and animals are not aware of the dangers of the shrub shears or thrown objects. Bystanders, children and animals may be seriously injured and damage to property may occur.
 - ▶ Keep bystanders, children and animals away from the work area.
- ▶ Do not leave the shrub shears unattended.
- ▶ Make sure that children cannot play with the shrub shears.
- The shrub shears are not waterproof. Working in the rain or a damp location may result in an electric shock. This can result in injuries to the user and may damage the shrub shears.
 - ▶ Do not work in the rain or a damp location.
- Electrical components of the shrub shears can produce sparks. Sparks may cause a fire or an explosion in an easily combustible or explosive environment. This can result in serious or fatal injuries and damage to property.
 - ▶ Do not work in an easily combustible or explosive environment.



4.4 Clothing and equipment

▲ WARNING

- Long hair may be caught in the shrub shears during operation. This may result in serious injury to the user.
 - ▶ Tie up and confine long hair above your shoulders.
- Objects can be thrown at high speed during operation. This may result in injury to the user.
 - ▶ Wear close-fitting safety glasses. Suitable safety glasses are tested in accordance with EN 166 or national regulations and available commercially with the corresponding marking.
 - ▶ Wear a long-sleeved, close-fitting top and long trousers.
- Dust can be whipped up during operation. Whipped up dust can damage the respiratory passages and cause allergic reactions.



4.5.2 Battery

▲ WARNING

- Bystanders, children and animals cannot recognize or assess the dangers of the battery. Bystanders, children and animals may be seriously injured.
 - ▶ Keep bystanders, children and animals away from the work area.
 - ▶ Do not leave the battery unattended.
 - ▶ Make sure that children cannot play with the battery.
- The battery is not protected against all ambient conditions. If the battery is exposed to certain ambient conditions, the battery may catch fire, explode or be irreparably damaged. This may result in serious injury to people and damage to property.



- ▶ Protect battery from heat and fire.
- ▶ Do not throw the battery into a fire.

- ▶ Do not charge, use and store the battery outside of the specified temperature limits,  19.6.



- ▶ Do not immerse the battery in liquids.

- ▶ Keep battery away from small metal parts.
- ▶ Do not expose the battery to high pressure.
- ▶ Do not expose the battery to microwaves.
- ▶ Protect the battery against chemicals and salts.

4.5.3 Charger

▲ WARNING

- Bystanders and children are not aware of and cannot assess the dangers of a charger or electric current. Bystanders, children and animals may be seriously or fatally injured.
 - ▶ Keep bystanders, children and animals away from the work area.
 - ▶ Make sure that children cannot play with the charger.
- The charger is not waterproof. If you work in rain or in a damp environment, an electric shock may occur. The user may be injured and the charger may be damaged.



- ▶ Do not operate it in the rain or in a damp environment.

- The charger is not protected against all ambient conditions. If the charger is exposed to certain ambient conditions, it may catch fire or

explode. This may result in serious injury to people and damage to property.

- ▶ Operate the charger in an enclosed, dry room.
- ▶ Do not operate the charger in a flammable environment or in an explosive environment.
- ▶ Do not operate the charger on a readily combustible surface.
- ▶ Do not use and store the charger outside of the specified temperature limits,  19.6.
- People may trip over the connecting cable. People may be injured and the charger may be damaged.
 - ▶ Lay the connecting cable flat on the floor.

4.6 Safe Condition

4.6.1 Shrub Shears

The shrub shears are in a safe condition if the following conditions apply:

- The shrub shears are not damaged.
- The shrub shears are clean and dry.
- The controls function properly and have not been modified.
- The shrub shear blade or grass shear blade is properly mounted.
- Genuine STIHL accessories designed for these shrub shears are fitted.
- The accessories are correctly attached.

▲ WARNING

- If not in safe condition, components may no longer operate correctly and safety devices may be disabled. There is a risk of serious or fatal injury to people.
 - ▶ Work only with undamaged shrub shears.
 - ▶ If the shrub shears are dirty or wet: Clean the shrub shears and allow them to dry.
 - ▶ Do not modify the shrub shears.
 - ▶ If the controls do not function properly: Do not use your shrub shears.
 - ▶ Fit genuine STIHL accessories designed for these shrub shears.
 - ▶ Attach accessories as described in this User Manual or in the User Manual for the accessories.
 - ▶ Never insert objects into the shrub shears' openings.
 - ▶ Replace worn or damaged labels.
 - ▶ If you have any doubts, be sure to consult a STIHL dealer.

4.6.2 Cutting Blades

The cutting blades are in a safe condition if the following points are observed:

- Cutting blades are undamaged.

- Cutting blades are not deformed.
- Cutting blades move freely.
- Cutting blades are properly sharpened.
- Cutting blades have no burrs.

⚠ WARNING

- If they are in an unsafe condition, parts of the cutting blades may come off and be thrown at high speed. This can result in serious injuries.
 - ▶ Work only with undamaged cutting blades.
 - ▶ Make sure the cutting blades are properly sharpened and deburred.
 - ▶ If you have any queries: Contact your STIHL servicing dealer.

4.6.3 Battery

The battery is in a safe condition if the following points are observed:

- Battery is undamaged.
- The battery is clean and dry.
- Battery functions properly and has not been modified.

⚠ WARNING

- A battery that is not in a safe condition cannot operate safely. Persons may be seriously injured.
 - ▶ Never work with a damaged battery.
 - ▶ Never attempt to charge a damaged or defective battery.
 - ▶ If the battery is dirty: Clean the battery.
 - ▶ If the battery is wet or damp: Allow the battery to dry,  19.7.
 - ▶ Never attempt to modify the battery.
 - ▶ Never insert objects in the battery's openings.
 - ▶ Never bridge the battery's contacts with metallic objects (short circuit).
 - ▶ Do not open the battery.
 - ▶ Replace worn or damaged labels.
- Fluid may leak from a damaged battery. If that liquid comes into contact with the skin or eyes, the skin or eyes may be irritated.
 - ▶ Avoid contact with the liquid.
 - ▶ If skin contact occurs: Wash affected areas of skin with plenty of water and soap.
 - ▶ In the event of contact with eyes: Rinse eyes with plenty of water for at least 15 minutes and consult a doctor.
- A damaged or defective battery may smell unusual, emit smoke or burn. Persons may be seriously or fatally injured, and property may be damaged.
 - ▶ If the battery smells unusual or emits smoke: do not use the battery and keep it away from combustible substances.

- ▶ If the battery catches fire: Attempt to extinguish the battery with a fire extinguisher or water.

4.6.4 Charger

The charger is in a safe condition if the following points are observed:

- Charger is undamaged.
- Charger is clean and dry.

⚠ WARNING

- If components do not comply with safety requirements, they will no longer function properly and safety devices may be rendered inoperative. This can result in serious or fatal injuries.
 - ▶ Do not use a damaged charger.
 - ▶ If the charger is dirty or wet: Clean the charger and allow it to dry.
 - ▶ Never attempt to modify the charger.
 - ▶ Never insert objects in the charger's openings.
 - ▶ Never bridge the charger's contacts with metallic objects (short circuit).
 - ▶ Do not open the charger.

4.7 Operation

⚠ WARNING

- The user cannot concentrate on the work in certain situations. The user may stumble, fall and be seriously injured.
 - ▶ Work calmly and carefully.
 - ▶ If light and visibility are poor: Do not use your shrub shears.
 - ▶ Operate the shrub shears alone.
 - ▶ Watch out for obstacles.
 - ▶ Stand on the ground while working and keep a good balance. If it is necessary to work at heights: Use a lift bucket or a safe platform.
 - ▶ If you begin to feel tired: Take a break.
- Working above shoulder height can cause you to tire quickly. This can result in serious injuries.
 - ▶ Work above shoulder height for short periods only.
 - ▶ Take regular breaks.
- If the moving cutting blades make contact with a hard object they can be brought to a sudden stop. The reactive forces that occur can cause the user to lose control of the shrub shears and be seriously injured.
 - ▶ Before starting work, check the shrub or grass for hard objects and remove any such objects.

- The moving cutting blades can cut the user.

This can result in serious injuries.



- ▶ Keep your free hand away from the cutting blades.
- ▶ Do not touch moving cutting blades.
- ▶ If the cutting blades are blocked by an object: Switch off the shrub shears and remove the battery. Then remove the object causing the blockage.

- If the behavior of the shrub shears changes during operation or feels unusual, it may no longer be in a safe condition. This can result in serious injuries and damage to property.

▶ Stop work, remove the battery and contact your STIHL servicing dealer for assistance.

- Vibrations may occur while using the shrub shears.
 - ▶ Wear gloves.
 - ▶ Take regular breaks.
 - ▶ If signs of circulation problems occur: Seek medical advice.

- Note that the cutting blades continue to run for about 1 second after you release the trigger.

The moving cutting blades can cut the user.

This can result in serious injuries.



- ▶ Hold the shrub shears firmly by the control handle and wait until the cutting blades come to a complete standstill.

⚠ DANGER

- Working near live electric cables can result in accidental contact with and damage to the cutting blades. This can result in serious or fatal injuries.

▶ Do not work near live electric cables.

4.8 Charging

⚠ WARNING

- A damaged or defective charger may produce an unusual smell or emit smoke during the charging process. This may result in personal injuries and damage to property.

▶ Disconnect the plug from the wall outlet.

- The charger can overheat and cause a fire if heat dissipation is inadequate. This can result in serious or fatal injuries and damage to property.

▶ Do not cover the charger.

4.9 Connecting to the power supply

Contact with live components may occur for the following reasons:

- The connecting cable or the extension cord is damaged.

- The mains plug of the connecting cable or extension cord is damaged.

- The socket is not properly installed.

⚠ DANGER

- Contact with live parts may result in electric shock. This may result in serious or fatal injury to the user.

- ▶ Make sure that the connecting cable, extension cord and their mains plugs are undamaged.



If the connecting cable or the extension cord is damaged:

- ▶ Do not touch the damaged area.
- ▶ Disconnect the mains plug from the power supply.

- ▶ Make sure your hands are dry before touching the connecting cable, extension cord or mains plugs.

- ▶ Plug the mains plug of the connecting cable or extension cord into a properly installed, shockproof socket with the correct fuse rating.

- ▶ Install the charger with a ground fault circuit interrupter (30 mA, 30 ms).

- A damaged or unsuitable extension cable can result in electric shock. There is a risk of serious or fatal injury.

- ▶ Use an extension cable with the correct cable cross-section, 19.5.

⚠ WARNING

- Overvoltage can occur in the charger if the line voltage or frequency are incorrect during charging. The charger may be damaged.

- ▶ Make sure that the mains voltage and the mains frequency of the power supply match the data on the rating plate of the charger.

- If the charger is connected to a power strip, electrical components may be overloaded during the charging process. The components may overheat and cause a fire. Persons may be seriously or fatally injured, and property may be damaged.

- ▶ Ensure that the technical specifications for the power strip are not exceeded by the information on the rating plate of the charger and of all electrical devices connected to the power strip.

- An incorrectly routed connecting cable or extension cord may be damaged, and people may trip over it. People may be injured, and the connecting cable or extension cord may be damaged.

- ▶ Route and mark the connecting cable and extension cord so that people will not trip over them.
- ▶ Route the connecting cable and extension cord so that they are not under tension or tangled.
- ▶ Route the connecting cable and extension cord so that they will not be damaged, kinked or crushed and will not be chafed.
- ▶ Protect the connecting cable and extension cord from heat, oil and chemicals.
- ▶ Lay the connecting cable and extension cord on a dry surface.
- The extension cable warms up in operation. If that heat cannot escape, it may cause a fire.
 - ▶ If using a cable reel: completely unroll the cable reel.
- If wiring and pipes are laid in the wall, they may be damaged if the charger is mounted on the wall. Contact with wiring can result in electric shock. This may result in serious injury to people and damage to property.
 - ▶ Make sure there is no wiring or pipes in the wall at the proposed mounting site.
- If the charger is not mounted on the wall as described in this User Manual, the charger or the battery may fall or the charger may overheat. This may result in injury to people and damage to property.
 - ▶ Mount the charger on a wall as described in this User Manual.
- If the charger is mounted on a wall with the battery inserted, the battery may fall out of the charger. This may result in injury to people and damage to property.
 - ▶ Mount the charger on the wall first before inserting the battery.

4.10 Transporting

4.10.1 Shrub Shears

▲ WARNING

- The shrub shears may turn over or shift during transport. This may result in personal injuries and damage to property.



- ▶ Remove the battery.

- ▶ Fit the blade scabbard so that it completely covers the cutting blades.
- ▶ Transport the battery in the bag supplied.
- ▶ If no bag is supplied with the battery: Secure the shrub shears with lashing

straps, belts or a net to prevent turnover and movement.

4.10.2 Battery

▲ WARNING

- The battery is not protected against all ambient conditions. The battery may be damaged if it is exposed to certain ambient conditions, and damage to property may occur.
 - ▶ Never transport a damaged battery.
 - ▶ If a bag is supplied: Transport the battery in the bag supplied.
- The battery may turn over or shift during transport. This may result in injury to people and damage to property.
 - ▶ Pack the battery in packaging in such a way that it cannot move.
 - ▶ Secure the packaging so that it cannot move.

4.10.3 Charger

▲ WARNING

- The charger can turn over or move while being transported. This may result in personal injuries and damage to property.
 - ▶ Disconnect the plug from the wall outlet.
 - ▶ Remove the battery.
 - ▶ Transport the charger in the bag supplied.
 - ▶ If no bag is supplied with the charger: Secure the charger with lashing straps, belts or a net to prevent it turning over and moving.
- The connecting cable must not be used for carrying the charger. The connecting cable and the charger may be damaged.
 - ▶ Wind up the connecting cable and attach it to the charger.

4.11 Storing

4.11.1 Shrub Shears

▲ WARNING

- Children are not aware of and cannot assess the dangers of shrub shears and can be seriously injured.



- ▶ Remove the battery.

- ▶ Fit the blade scabbard so that it completely covers the cutting blades.
- ▶ Store the shrub shears out of the reach of children.

- Dampness can corrode the electrical contacts on the shrub shears and metal components. This can damage the shrub shears.



- ▶ Remove the battery.

- ▶ Store the shrub shears in a clean and dry condition.

4.11.2 Battery

⚠ WARNING

- Children are not aware of and cannot assess the dangers of the battery. Children may be seriously injured.
 - ▶ Store the battery out of the reach of children.
- The battery is not protected against all ambient conditions. If the battery is exposed to certain ambient conditions, the battery may be irreparably damaged.
 - ▶ Store the battery in a clean and dry condition.
 - ▶ Store the battery in an enclosed space.
 - ▶ Store the battery separately from the shrub shears.
 - ▶ If the battery is stored in the charger, disconnect the mains plug and store the rechargeable battery at a battery charge status between 40% and 60% (2 lit green LEDs).
 - ▶ Do not store the battery outside of the specified temperature limits, 19.6.

4.11.3 Charger

⚠ WARNING

- Children are not aware of and cannot assess the dangers of a charger. Children can be seriously injured or killed.
 - ▶ Disconnect the plug from the wall outlet.
 - ▶ Store the charger out of reach of children.
- The charger is not protected against all ambient conditions. If the charger is exposed to certain ambient conditions, the charger may be damaged.
 - ▶ Disconnect the plug from the wall outlet.
 - ▶ If the charger is hot: Allow the charger to cool down.
 - ▶ Store the charger in a clean, dry place.
 - ▶ Store the charger in an enclosed room.
 - ▶ Do not store the charger outside of the specified temperature limits, 19.6.
- The connecting cable should not be used for carrying the charger or hanging up the

charger. The connecting cable and the charger may be damaged.

- ▶ Hold the charger by the housing in a secure grip.
- ▶ Hang the charger on the wall mounting.

4.12 Cleaning, Maintenance and Repair

⚠ WARNING

- The shrub shears may start unintentionally if the battery is left in place during cleaning, maintenance or repair operations. This may result in serious injury to people and damage to property.
 - ▶ Remove the battery.
- Sharp cleaning agents, cleaning with a water jet or pointed objects can damage the shrub shears, the cutting blades, the battery and the charger. If the shrub shears, cutting blades, battery or charger are not cleaned correctly, components may no longer function properly or safety devices may be rendered inoperative. This may cause serious injury to persons.
 - ▶ Clean the shrub shears, cutting blades, battery and charger as described in this instruction manual.
- If the shrub shears, cutting blades, battery or charger are not serviced correctly, components may no longer function properly or safety devices may be rendered inoperative. There is a risk of serious or fatal injury to people.
 - ▶ Do not attempt to service or repair the shrub shears, battery or charger.
 - ▶ If the shrub shears, battery or the charger require servicing or repairs: Contact your STIHL servicing dealer for assistance.
 - ▶ Maintain the cutting blades as described in this User Manual.
- The user can be cut by the sharp cutting edges while cleaning or servicing the cutting blades. This may result in injury to the user.
 - ▶ Wear work gloves made from resistant material.



5 Preparing Shrub Shears for Operation

5.1 Preparing Shrub Shears for Operation

The following steps must be performed before commencing work:

- ▶ Ensure that the following components are in safe condition:
 - Shrub shears, 4.6.1.
 - Cutting blades, 4.6.2.
 - Battery, 4.6.3.
 - Charger, 4.6.4.
- ▶ Check the battery, 10.2.
- ▶ Fully charge the battery, 6.2.
- ▶ Clean the shrub shears, 15.1.
- ▶ Check the controls, 10.1.
- ▶ If you cannot carry out this work: Do not use your shrub shears and contact your STIHL servicing dealer.

6 Charging the Battery, LEDs

6.1 Mounting the charger on a wall

The charger can be mounted on a wall.

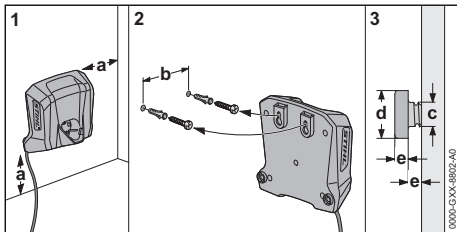

- ▶ Check the following points when mounting the charger on a wall:
 - Use suitable mounting materials.
 - The charger is level.
 The following dimensions are observed:
 - a = at least 100 mm
 - b = 54 mm
 - c = 4.5 mm
 - d = 9 mm
 - e = 2.5 mm

6.2 Charging the Battery

The charging time depends on various factors, e.g. the battery temperature or the ambient temperature. For optimum performance, note the recommended temperature ranges, 19.7. The actual charging time may vary from the charging time indicated. The charging time is indicated at www.stihl.com/charging-times.

The charging process starts automatically when the mains plug is plugged into a socket and the battery is inserted into the charger. The charger switches off automatically when the battery is fully charged.

The battery and the charger warm up during charging.

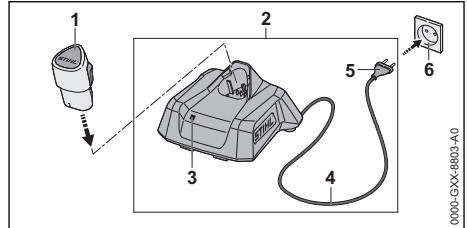

- ▶ Insert the mains plug (5) in a convenient wall outlet (6).
The charger (2) runs a self test. The LED (3) glows green for about 1 second and then red for about 1 second.
- ▶ Fit the connecting cable (4).
- ▶ Insert the battery (1) in the guides in the charger (2) and press it home as far as stop.
The LED (3) glows or flashes green. The battery (1) is being charged.
- ▶ When the LED (3) stops glowing: The battery (1) is fully charged and can be taken out of the charger (2).
- ▶ If the charger (2) is no longer being used: Disconnect the mains plug (5) from the socket (6).

6.3 Displaying State of Charge

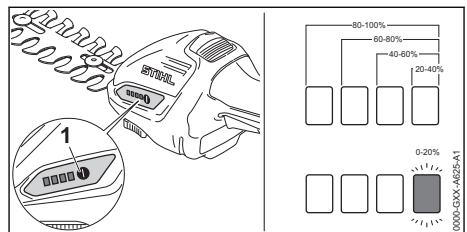

- ▶ Insert battery.
- ▶ Press the button (1).
The LEDs emit green light for about 5 seconds and indicate the state of charge.
- ▶ If the LED on the right flashes green: Charge the battery.

6.4 LEDs on Shrub Shears

The LEDs can show the state of charge or malfunctions. The LEDs can glow or flash green or red.

The state of charge is indicated when the LEDs glow or flash green.

- ▶ If the LEDs glow or flash red: Troubleshooting,  18.1.
There is a malfunction in the shrub shears or battery.

6.5 LED on Charger

The LED indicates the operating status of the charger or faults. The LED can glow or flash green or red.

If the LED glows or flashes green, the battery is being charged.

- ▶ If the LED glows or flashes red: Troubleshooting,  18.2.
There is a malfunction in charger or battery.

7 Assembling the Shrub Shears

7.1 Fitting and Removing the Cutting Blades

7.1.1 Fitting the Shrub Shear Blade or Grass Shear Blade

The shrub shear blade and grass shear blade are fitted on the shrub shears in the same way.

- ▶ Switch off the shrub shears and remove the battery.
- ▶ Fit the blade scabbard so that it completely covers the cutting blades.

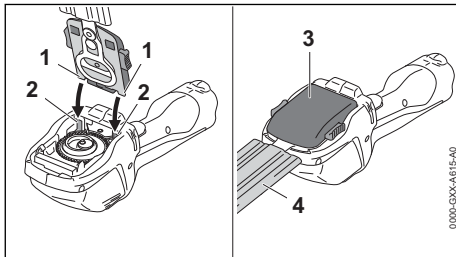

- ▶ Engage the lugs (1) of the shrub shear blade (3) or grass shear blade (3) on the guides (2).
- ▶ Swing the shrub shear blade (3) or grass shear blade (3) down and press it firmly into place.
The shrub shear blade (3) or grass shear blade (3) engages with an audible click.
- ▶ Remove the blade scabbard (4).

7.1.2 Removing the Shrub Shear Blade or Grass Shear Blade

The shrub shear blade and grass shear blade are removed in the same way.

- ▶ Switch off the shrub shears and remove the battery.
- ▶ Fit the blade scabbard so that it completely covers the cutting blades.

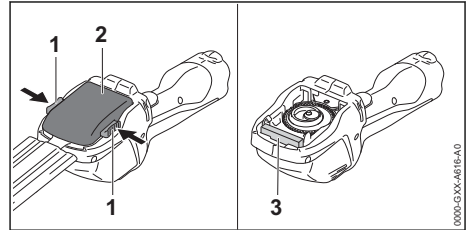

- ▶ Press in both locking levers (1).
The shrub shear blade (2) or grass shear blade (2) is unlocked.
- ▶ Remove the shrub shear blade (2) or grass shear blade (2).

A foam seal (3) protects the gearbox from contamination during operation. The seal (3) is permanently connected to the shrub shears and cannot be removed.

8 Removing and Fitting the Battery

8.1 Fitting the Battery

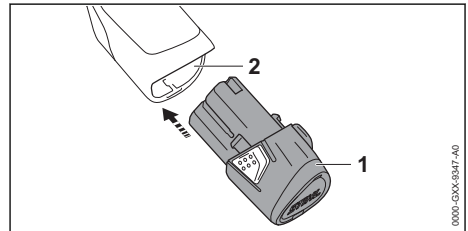

- ▶ Push the battery (1) into the battery compartment (2) as far as stop.
The battery (1) engages in position with a click.

8.2 Removing the Battery

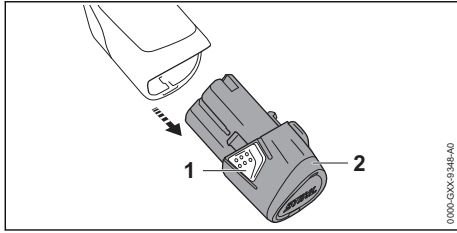

- ▶ Depress both locking hooks (1). The battery (2) is unlocked and can be removed.

9 Switching the Shrub Shears On/Off

9.1 Switching On

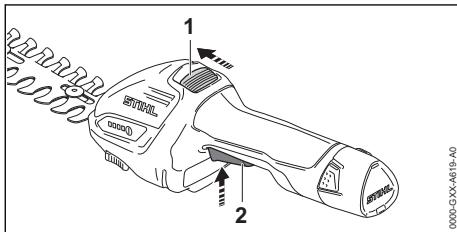

- ▶ Push the release slide (1) in the direction of the cutting blades with your thumb and hold it there.
- ▶ Pull the trigger (2) with your index finger and hold it there. You can let go of the release slide (1). The motor accelerates and the cutting blades run.

9.2 Switching Off

- ▶ Let go of the trigger and release slide.
- ▶ Wait until the cutting blades come to a complete standstill after about 1 second.
- ▶ If the cutting blades continue to run after about 1 second: Remove the battery and contact your STIHL servicing dealer. There is a malfunction in the shrub shears.

10 Checking the Shrub Shears and Battery

10.1 Checking the Controls

Release slide and trigger

- ▶ Remove the battery.
- ▶ Attempt to pull the trigger lever without depressing the release slide.

- ▶ If the trigger can be pulled: Do not use your shrub shears and contact your STIHL servicing dealer. The release slide has a malfunction.
- ▶ Push the release slide in the direction of the cutting blades with your thumb and hold it there.
- ▶ Pull the trigger.
- ▶ Let go of the trigger and release slide.
- ▶ If the trigger or the release slide is stiff or does not spring back to the idle position: Do not use your shrub shears and contact your STIHL servicing dealer. The trigger or release slide has a malfunction.

Switch on the shrub shears

- ▶ Fit the battery.
- ▶ Push the release slide in the direction of the cutting blades with your thumb and hold it there.
- ▶ Pull the trigger and hold it there. The cutting blades run.
- ▶ Release the trigger. The cutting blades stop running after about 1 second.
- ▶ If the cutting blades continue to run after 1 second: Remove the battery and contact your STIHL servicing dealer. There is a malfunction in the shrub shears.

10.2 Testing the Battery

- ▶ Fit the battery.
- ▶ Depress the button on the shrub shears. The LEDs glow or flash.
- ▶ If the LEDs do not glow or flash: Do not use your shrub shears or battery and contact your STIHL dealer for assistance. There is a malfunction in the shrub shears or battery.

11 Operating the Shrub Shears

11.1 Holding and Controlling the Shrub Shears

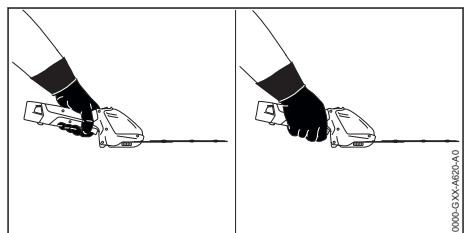

- ▶ Hold the shrub shears with one hand on the control handle - wrap your thumb around the handle.
- ▶ Keep your free hand away from the cutting blades.

11.2 Cutting Shrubs

- ▶ Mount the shrub shear blades.
- ▶ Use pruning shears, a hedge trimmer or chain-saw to cut thick branches first.

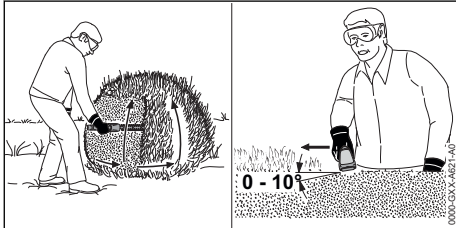

- ▶ Make a cut while swinging the shrub shears in an upward arc.
- ▶ Bring the shrub shears down without cutting.
- ▶ Progress forward slowly and in a controlled manner.
- ▶ Swing the shrub shears in an upwards arc again to cut.
- ▶ Cut the other side of the shrub in the same way.
- ▶ Hold the cutting blades at an angle of 0° to 10° from the top of the shrub.
- ▶ Swing the shrub shears in a horizontal arc to cut.
- ▶ If cutting performance deteriorates: Sharpen the cutting blades.

For optimum performance, observe the recommended temperature ranges,  19.7.

11.3 Cutting Grass

- ▶ Mount the grass shear blades.

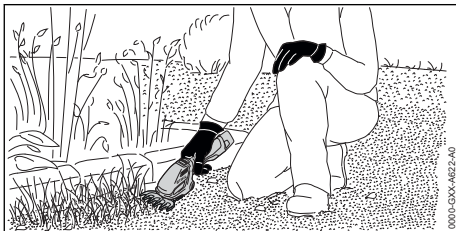

- ▶ Hold the shrub shears at the required height while cutting the grass.

For optimum performance, observe the recommended temperature ranges,  19.7.

12 After Finishing Work

12.1 After Finishing Work

- ▶ Switch off the shrub shears and remove the battery.
- ▶ If the shrub shears are wet: Allow the shrub shears to dry.
- ▶ If the battery is moist or wet: Allow the battery to dry,  19.7.
- ▶ If the battery is wet: Allow the battery to dry.
- ▶ Clean the shrub shears.
- ▶ Clean the cutting blades.
- ▶ Fit or fold the blade scabbard so that it completely covers the cutting blades.
- ▶ Clean the battery.

13 Transporting

13.1 Transporting the shrub shears

- ▶ Switch off the shrub shears and remove the battery.
- ▶ Fit the blade scabbard so that it completely covers the cutting blades.

Carrying the shrub shears

- ▶ Carry the shrub shears in one hand by the control handle.

Transporting the shrub shears in the car

- ▶ Transport the shrub shears in the bag supplied.
- ▶ Secure the bag to prevent it from tipping and moving.
- ▶ If no bag is supplied with the shrub shears: Secure the shrub shears to prevent turnover and movement.

13.2 Transporting the Battery

- ▶ Switch off the shrub shears and remove the battery.
- ▶ Check that the battery is in a safe condition.
- ▶ Pack the battery in the bag supplied.
- ▶ If no bag is supplied with the battery: Pack the battery in packaging in such a way that it cannot move.
- ▶ Secure the packaging so that it cannot move.

The battery is subject to the Carriage of Dangerous Goods regulations. The battery is classified as UN 3480 (lithium ion batteries) and has been tested pursuant to UN Manual Tests and Criteria Part III, Subsection 38.3.

The transport regulations can be found at www.stihl.com/safety-data-sheets.

13.3 Transporting the Charger

- ▶ Disconnect the plug from the wall outlet.

- ▶ Remove the battery.
- ▶ Wind up the connecting cable and attach it to the charger.
- ▶ Transporting the charger in a vehicle:
 - ▶ Transport the charger in the bag supplied.
 - ▶ Secure the bag to prevent turnover and movement.
 - ▶ If no bag is supplied with the charger: Secure the charger to prevent turnover and movement.

14 Storing

14.1 Storing the shrub shears

- ▶ Switch off the shrub shears and remove the battery.
- ▶ Fit or fold the blade scabbard so that it completely covers the cutting blades.
- ▶ Observe the following points when storing the shrub shears:
 - Secure the shrub shears to prevent them from tipping over or shifting.
 - The shrub shears are out of the reach of children.
 - The shrub shears are clean and dry.

14.2 Storing the Battery

STIHL recommends keeping the battery in a charging state between 40% and 60 % (2 green LEDs lit).

- ▶ The battery should be stored in such a way that the following conditions are fulfilled:
 - The battery is out of the reach of children.
 - The battery is clean and dry.
 - The battery is in an enclosed space.
 - The battery is stored separately from the shrub shears.
 - If the battery is stored in the charger, disconnect the mains plug and store the rechargeable battery at a battery charge status between 40% and 60% (2 lit green LEDs).
 - Do not store the battery outside of the specified temperature limits,  19.6.

NOTICE

- If the battery is not stored as described in this user manual, the battery may become deeply discharged and irreparably damaged.
 - ▶ Charge a discharged battery before storing it. STIHL recommends keeping the battery in a charging state between 40% and 60% (2 lit green LEDs).
 - ▶ Store the battery separately from the shrub shears.

14.3 Storing the Charger

- ▶ Disconnect the mains plug from the power supply.

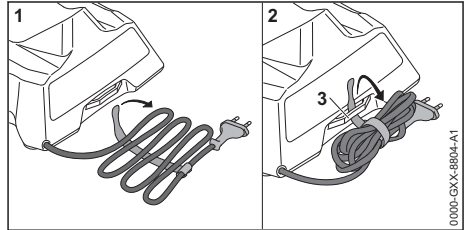

- ▶ Wind up the connecting cable and attach it to the charger.
- ▶ Observe the following points when storing the charger:
 - Charger is out of the reach of children.
 - The charger is clean and dry.
 - Charger is in an enclosed space.
 - The charger is not suspended from the connecting cable or the holder (3) for the connecting cable.
 - Do not store the charger outside of the specified temperature limits,  19.6.

15 Cleaning

15.1 Cleaning the Shrub Shears

- ▶ Switch off the shrub shears and remove the battery.
- ▶ Clean the shrub shears with a damp cloth or STIHL resin solvent.
- ▶ Clean vents with a paintbrush.
- ▶ Remove foreign objects from the battery compartment and clean the battery compartment with a damp cloth.
- ▶ Clean the electrical contacts in the battery compartment with a paintbrush or soft brush.

15.2 Cleaning the Cutting Blades

- ▶ Switch off the shrub shears and remove the battery.
- ▶ Spray both sides of blades with STIHL resin solvent.
- ▶ Fit the battery.
- ▶ Switch on the shrub shears for 5 seconds. The cutting blades run. STIHL resin solvent is distributed evenly.

15.3 Cleaning the Battery

- ▶ Clean the battery with a damp cloth.

15.4 Cleaning the Charger

- ▶ Disconnect the mains plug from the power supply.

- ▶ Clean the charger with a damp cloth.
- ▶ Clean the charger's electrical contacts with a paintbrush or a soft brush.

16 Maintenance

16.1 Sharpening the Cutting Blades



Shrub shear blades

STIHL recommends you have the cutting blades resharpened by a STIHL servicing dealer.

! WARNING

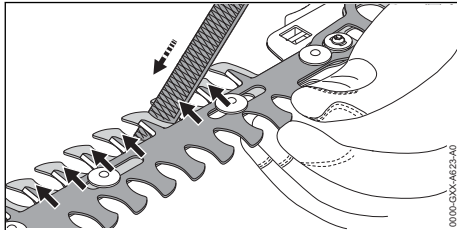
- The teeth of the cutting blades are very sharp. There is a risk of cut injuries.
 - ▶ Wear work gloves made of durable material.
- ▶ Switch off the shrub shears and remove the battery.
- ▶ Remove the shrub shear blades,  7.1.2.



- ▶ Move the cutting blades so that the cutting edges are easily accessible.
- ▶ Use a flat crosscut file to sharpen each cutting edge on the upper blade. The file only sharpens on the forward stroke. Maintain the prescribed sharpening angle,  19.2.
- ▶ Turn shrub shear blades over.
- ▶ Sharpen the remaining cutting edges.
- ▶ Use a damp cloth to remove the filing dust.
- ▶ Spray both sides of shrub shear blades with STIHL resin solvent.
- ▶ Mount the shrub shear blades,  7.1.1.
- ▶ Switch on the shrub shears for 5 seconds. The cutting blades run. STIHL resin solvent is distributed evenly.
- ▶ If you have any queries: Contact a STIHL servicing dealer for assistance.



Grass shear blades

STIHL recommends you have the cutting blades resharpened by a STIHL servicing dealer.

! WARNING

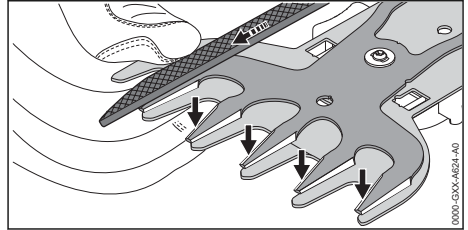
- The teeth of the cutting blades are very sharp. There is a risk of cut injuries.
 - ▶ Wear work gloves made of durable material.
- ▶ Switch off the shrub shears and remove the battery.
- ▶ Remove the grass shear blades,  7.1.2.



- ▶ Push the upper cutting blade fully in one direction so that one side of the cutting edges is easily accessible.
- ▶ Use a flat crosscut file to sharpen each cutting edge on the upper blade. The file only sharpens on the forward stroke. Maintain the prescribed sharpening angle,  19.2.
- ▶ Push the upper cutting blade fully in the other direction so that the other side of the cutting edges is easily accessible.
- ▶ Sharpen the remaining cutting edges.
- ▶ Use a damp cloth to remove the filing dust.
- ▶ Spray both sides of grass shear blades with STIHL resin solvent.
- ▶ Mount the grass shear blades,  7.1.1.
- ▶ Switch on the shrub shears for 5 seconds. The cutting blades run. STIHL resin solvent is distributed evenly.
- ▶ If you have any queries: Contact a STIHL servicing dealer for assistance.

17 Repairing

17.1 Repairing the Shrub Shears, Battery and Charger

The shrub shears, cutting blades, battery and charger are not user serviceable.

- ▶ If the shrub shears are damaged: Do not use your shrub shears and contact your STIHL servicing dealer.
- ▶ If the cutting blades are damaged: Replace the cutting blades.
- ▶ If the battery has a malfunction or is damaged: Replace the battery.
- ▶ If the charger has a malfunction or is damaged: Replace the charger.

- If the connecting cable has a malfunction or is damaged: Do not use the charger and have connecting cable replaced by a STIHL servicing dealer.

18 Troubleshooting

18.1 Troubleshooting shrub shears and battery

Fault	LEDs on shrub shears	Cause	Remedy
Shrub shears do not start when switched on.	1 LED flashing green.	State of charge of the battery is too low.	► Charge the battery.
	1 LED emits red light.	The battery is too warm or too cold.	► Remove the battery. ► Allow the battery to cool down or warm up.
	3 LEDs flashing red.	There is a malfunction in the shrub shears.	► Remove battery and reinsert it. ► Switch on the shrub shears. ► If 3 LEDs continue to flash red: Do not use the shrub shears and contact your STIHL dealer for assistance.
	3 LEDs light up red.	Shrub shears are too hot.	► Remove the battery. ► Allow the shrub shears to cool down.
	4 LEDs flash red.	There is a fault in the battery.	► Remove the battery. ► Clean electrical contacts in the battery compartment. ► Insert battery. ► Switch on the shrub shears. ► If 4 LEDs continue to flash red: Do not use the battery; contact a STIHL authorized dealer.
		No electrical contact between the shrub shears and battery.	► Remove the battery. ► Clean electrical contacts in the battery compartment. ► Insert battery.
		Shrub shears or battery are damp.	► Allow the shrub shears or battery to dry,  19.7.
The shrub shears cut out during operation.		The cutting blades do not run freely.	► Spray both sides of cutting blades with STIHL resin solvent. ► If shrub shears still do not start when switched on: Do not use your shrub shears and contact your STIHL dealer.
	3 LEDs light up red.	Shrub shears are too hot.	► Remove the battery. ► Allow the shrub shears to cool down.
Cutting performance of shrub shears deteriorates.		There is an electrical fault.	► Remove battery and reinsert it. ► Switch on the shrub shears.
	1 LED flashes green.	State of charge of the battery is too low.	► Charge the battery.
The shrub shears runtime is too short.		The cutting blades do not run freely.	► Spray both sides of cutting blades with STIHL resin solvent.
		The battery is not fully charged.	► Fully charge the battery.
		The battery service life has been exceeded.	► Replace battery.

18.2 Troubleshooting the Charger

Fault	LED on Charger	Cause	Remedy
Battery not being charged.	One LED glows red.	The battery is too warm or too cold.	<ul style="list-style-type: none"> ▶ Leave battery inserted in charger. Charging starts automatically as soon as the permitted temperature range is reached.
	The LED flashes red.	No electrical contact between charger and battery.	<ul style="list-style-type: none"> ▶ Remove the battery. ▶ Clean contacts on charger. ▶ Insert battery.
		There is a malfunction in the charger.	<ul style="list-style-type: none"> ▶ Do not use the charger and contact your STIHL dealer for assistance.
		There is a fault in the battery.	<ul style="list-style-type: none"> ▶ Do not use the battery. Consult a STIHL dealer.
The charger does not run a self test.	The LED glows green for about 1 second and then red for about 1 second.	Electrical contact to charger was briefly interrupted.	<ul style="list-style-type: none"> ▶ Disconnect the mains plug from the power supply. ▶ Wait for 1 minute. ▶ Insert the mains plug in a wall outlet.

19 Specifications

19.1 STIHL HSA 26 Shrub Shears

- Approved battery: STIHL AS
- Weight without battery:
- with shrub shear blades: 0.8 kg
- with grass shear blades: 0.7 kg

For battery life see www.stihl.com/battery-life.

19.2 Shrub Shear Blades, Grass Shear Blades

Shrub shear blades

- Maximum opening: 8 mm
- Tooth spacing: 19 mm
- Cutting length: 200 mm
- Sharpening angle: 30°

Grass shear blades

- Tooth spacing: 16 mm
- Cutting length: 120 mm
- Sharpening angle: 35°

19.3 STIHL AS Battery

- Battery Technology: Lithium-ion
- Voltage: 10.8 V
- Capacity in Ah: see rating label
- Energy content in Wh: see rating label
- Weight in kg: see rating label

19.4 STIHL AL 1 Charger

- Rated voltage: see rating plate
- Frequency: see rating plate
- Rated power: see rating plate
- Charging current: see rating plate

- Maximum energy content of approved STIHL AS battery: 12.5 Ah

For charging times see www.stihl.com/charging-times.

19.5 Extension Cords

If an extension cord is used, the cross sectional area of its conductors must meet the following minimum requirements – depending on the line voltage and length of the extension cord:

If rated voltage on the rating label is 220V to 240V:

- Cord length up to 20 m: AWG 15 / 1.5 mm²
- Cord length 20 m up to 50 m: AWG 13 / 2.5 mm²

If rated voltage on the rating label is 100V to 127V:

- Cord length up to 10 m: AWG 14 / 2.0 mm²
- Cord length 10 m up to 30 m: AWG 12 / 3.5 mm²

19.6 Temperature limits



WARNING

- The battery is not protected against all ambient conditions. If the battery is exposed to certain environmental conditions, it may catch fire or explode. This may result in serious injury to people and damage to property.
 - ▶ Do not charge the battery below -20°C or above 50°C .
 - ▶ Do not use the shrub shears, battery or charger below -20°C or above $+50^{\circ}\text{C}$.
 - ▶ Do not store the shrub shears, battery or charger below -20°C or above $+70^{\circ}\text{C}$.

19.7 Recommended temperature ranges

For optimum performance of the shrub shears, batteries and charger, observe the following temperature ranges:

- Charging: 5°C to 40°C
- Use: -10°C to $+40^{\circ}\text{C}$
- Storage: -20°C to $+50^{\circ}\text{C}$

If the battery is charged, used or stored outside the recommended temperature ranges, performance may be reduced.

If the battery is wet or moist, allow the battery to dry for at least 48 h between 15°C and 50°C and with less than 70% humidity. Higher humidity may extend the drying time.

19.8 Sound Values and Vibration Values

The K-value for sound pressure levels is 2 dB(A). K-value for sound power levels is 2 dB(A). The K-value for vibration level is 2 m/s^2 .

HSA 26

- Sound pressure level L_{pA} measured according to EN 62841-4-2: 69 dB(A).
- Sound power level L_{WA} measured as specified in EN 62841-4-2: 80 dB(A)
- Vibration level a_{HV} measured according to EN 62841-4-2: 1 m/s^2

The vibration levels indicated were measured according to a standardized test method and can be used as a basis for comparing electric power tools. The vibration levels actually occurring may vary from the values indicated, depending on the type of application. The vibration levels indicated can be used for an initial estimate of the vibration stress. The actual vibration stress has to be estimated. The times when the electric power tool is

switched off and the times when it is switched on but running under no load can be taken into account in the estimate.

For information on compliance with Employers' Vibration Directive 2002/44/EC see www.stihl.com/vib.

19.9 REACH

REACH is an EC regulation and stands for the Registration, Evaluation, Authorisation and Restriction of Chemical substances.

For information on compliance with the REACH regulation see www.stihl.com/reach.

20 Spare Parts and Accessories

20.1 Spare parts and accessories

STIHL  These symbols indicate original STIHL spare parts and original STIHL accessories.

STIHL recommends the use of original STIHL spare parts and accessories.

Despite ongoing market observation, STIHL is unable to judge the reliability, safety and suitability of other manufacturers' spare parts and accessories; accordingly, STIHL cannot warrant for the use of those parts.

Original STIHL spare parts and original STIHL accessories are available from STIHL dealers.

21 Disposal

21.1 Disposal of Shrub Shears, Battery and Charger

Contact the local authorities or your STIHL dealer for information on disposal.

Improper disposal can be harmful to health and pollute the environment.

- ▶ Take STIHL products including packaging to a suitable collection point for recycling in accordance with local regulations.
- ▶ Do not dispose with domestic waste.

22 EC Declaration of Conformity

22.1 STIHL HSA 26 Shrub Shears

ANDREAS STIHL AG & Co. KG
Badstraße 115
D-71336 Waiblingen

Germany

declare under our sole responsibility that

- Category: Battery shrub shears with shrub and grass shear blades
- Manufacturer's brand: STIHL
- Model: HSA 26
- Serial identification: HA03

conforms to the relevant provisions of Directives 2011/65/EU, 2006/42/EC, 2014/30/EU and 2000/14/EC and has been developed and manufactured in compliance with the following standards in the versions valid on the date of production: EN 55014-1, EN 55014-2, EN 62841-1, EN 62841-4-2 and EN 62841-4-5.

Applied conformity assessment procedure in accordance with Directive 2000/14/EC, Annex V.

- Measured sound power level: 80 dB(A)
- Guaranteed sound power level: 82 dB(A)

The technical documents are stored at ANDREAS STIHL AG & Co. KG Produktzulassung.

The year of manufacture, country of manufacture and serial number are shown on the shrub shears.

Waiblingen, 2024-02-21

ANDREAS STIHL AG & Co. KG

pp 

Robert Olma, Vice President, Regulatory Affairs & Global Governmental Relations

23 UKCA Declaration of Conformity

23.1 STIHL HSA 26 Shrub Shears



ANDREAS STIHL AG & Co. KG
Badstraße 115
D-71336 Waiblingen

Germany

declare under our sole responsibility that

- Category: Battery shrub shears with shrub and grass shear blades
- Manufacturer's brand: STIHL
- Model: HSA 26
- Serial identification: HA03

conforms to the relevant provisions of UK regulations The Restriction of the Use of Certain Hazardous Substances in Electrical and Electronic Equipment Regulation 2012, Supply of Machinery (Safety) Regulations 2008, Electromagnetic Compatibility Regulations 2016 and Noise Emission in the Environment by Equipment for Use Outdoors Regulations 2001 and has been manufactured in compliance with the following standards in the versions valid on the date of production: EN 55014-1, EN 55014-2, EN 62841-1, EN 62841-4-2 and EN 62841-4-5.

Applied conformity assessment procedure in accordance with UK regulations Noise Emission in the Environment by Equipment for Use Outdoors Regulations 2001, Schedule 8.

- Measured sound power level: 80 dB(A)
- Guaranteed sound power level: 82 dB(A)

The technical documents are stored at ANDREAS STIHL AG & Co. KG Produktzulassung.

The year of manufacture, country of manufacture and serial number are shown on the shrub shears.

Waiblingen, 2024-02-21

ANDREAS STIHL AG & Co. KG

pp 

Robert Olma, Vice President, Regulatory Affairs & Global Governmental Relations

24 Addresses

www.stihl.com

25 General Power Tool Safety Warnings

25.1 Introduction

This chapter reproduces the pre-formulated, general safety precautions specified in the IEC 62841 standard for hand-held motor-operated electric tools.

STIHL is obliged to publish these texts.

The safety precautions and warnings on avoiding an electric shock given under "Electrical Safety" do not apply to STIHL cordless products.

WARNING

- **Read all safety warnings, instructions, illustrations and specifications provided with this power tool.** Failure to follow all instructions listed below may result in electric shock, fire and/or serious injury. **Save all warnings and instructions for future reference.**

The term "electric power tool" in the safety warnings refers to mains-operated (corded) power tools or battery-operated (cordless) power tools.

25.2 Work area safety

- a) **Keep work area clean and well lit.** Cluttered or dark areas invite accidents.
- b) **Do not operate power tools in explosive atmospheres, such as in the presence of flammable liquids, gases or dust.** Power tools create sparks which may ignite the dust or fumes.
- c) **Keep children and bystanders away while operating a power tool.** Distractions can cause you to lose control.

25.3 Electrical safety

- a) **Power tool plugs must match the outlet. Never modify the plug in any way. Do not use any adapter plugs with earthed (grounded) power tools.** Unmodified plugs and matching outlets will reduce risk of electric shock.
- b) **Avoid body contact with earthed or grounded surfaces, such as pipes, radiators, ranges and refrigerators.** There is an increased risk of electric shock if your body is earthed or grounded.
- c) **Do not expose power tools to rain or wet conditions.** Water entering a power tool will increase the risk of electric shock.
- d) **Do not abuse the cord. Never use the cord for carrying, pulling or unplugging the power tool. Keep cord away from heat, oil, sharp edges or moving parts.** Damaged or entangled cords increase the risk of electric shock.
- e) **When operating a power tool outdoors, use an extension cord suitable for outdoor use.** Use of a cord suitable for outdoor use reduces the risk of electric shock.
- f) **If operating a power tool in a damp location is unavoidable, use a residual current device (RCD) protected supply.** Use of an RCD reduces the risk of electric shock.

25.4 Personal safety

- a) **Stay alert, watch what you are doing and use common sense when operating a power tool. Do not use a power tool while you are tired or under the influence of drugs, alcohol or medication.** A moment of inattention while operating power tools may result in serious personal injury.
- b) **Use personal protective equipment. Always wear eye protection.** Protective equipment such as a dust mask, non-skid safety shoes, hard hat or hearing protection used for appropriate conditions will reduce personal injuries.
- c) **Prevent unintentional starting. Ensure the switch is in the off-position before connecting to power source and/or battery pack, picking up or carrying the tool.** Carrying power tools with your finger on the switch or energising power tools that have the switch on invites accidents.
- d) **Remove any adjusting key or wrench before turning the power tool on.** A wrench or a key left attached to a rotating part of the power tool may result in personal injury.
- e) **Do not overreach. Keep proper footing and balance at all times.** This enables better control of the power tool in unexpected situations.
- f) **Dress properly. Do not wear loose clothing or jewellery. Keep your hair and clothing away from moving parts.** Loose clothes, jewellery or long hair can be caught in moving parts.
- g) **If devices are provided for the connection of dust extraction and collection facilities, ensure these are connected and properly used.** Use of dust collection can reduce dust-related hazards.
- h) **Do not let familiarity gained from frequent use of tools allow you to become complacent and ignore tool safety principles.** A careless action can cause severe injury within a fraction of a second.

25.5 Power tool use and care

- a) **Do not force the power tool. Use the correct power tool for your application.** The correct power tool will do the job better and safer at the rate for which it was designed.
- b) **Do not use the power tool if the switch does not turn it on and off.** Any power tool that cannot be controlled with the switch is dangerous and must be repaired.

- c) **Disconnect the plug from the power source and/or remove the battery pack, if detachable, from the power tool before making any adjustments, changing accessories, or storing power tools.** Such preventive safety measures reduce the risk of starting the power tool accidentally.
- d) **Store idle power tools out of the reach of children and do not allow persons unfamiliar with the power tool or these instructions to operate the power tool.** Power tools are dangerous in the hands of untrained users.
- e) **Maintain power tools and accessories. Check for misalignment or binding of moving parts, breakage of parts and any other condition that may affect the power tool's operation. If damaged, have the power tool repaired before use.** Many accidents are caused by poorly maintained power tools.
- f) **Keep cutting tools sharp and clean.** Properly maintained cutting tools with sharp cutting edges are less likely to bind and are easier to control.
- g) **Use the power tool, accessories and tool bits etc. in accordance with these instructions, taking into account the working conditions and the work to be performed.** Use of the power tool for operations different from those intended could result in a hazardous situation.
- h) **Keep handles and grasping surfaces dry, clean and free from oil and grease.** Slippery handles and grasping surfaces do not allow for safe handling and control of the tool in unexpected situations.

25.6 Battery tool use and care

- a) **Recharge only with the charger specified by the manufacturer.** A charger that is suitable for one type of battery pack may create a risk of fire when used with another battery pack.
- b) **Use power tools only with specifically designated battery packs.** Use of any other battery packs may create a risk of injury and fire.
- c) **When battery pack is not in use, keep it away from other metal objects, like paper clips, coins, keys, nails, screws or other small metal objects, that can make a connection from one terminal to another.** Shorting the battery terminals together may cause burns or a fire.

- d) **Under abusive conditions, liquid may be ejected from the battery; avoid contact. If contact accidentally occurs, flush with water. If liquid contacts eyes, additionally seek medical help.** Liquid ejected from the battery may cause irritation or burns.
- e) **Do not use a battery pack or tool that is damaged or modified.** Damaged or modified batteries may exhibit unpredictable behaviour resulting in fire, explosion or risk of injury.
- f) **Do not expose a battery pack or tool to fire or excessive temperature.** Exposure to fire or temperature above 130 °C may cause explosion.
- g) **Follow all charging instructions and do not charge the battery pack or tool outside the temperature range specified in the instructions.** Charging improperly or at temperatures outside the specified range may damage the battery and increase the risk of fire.

25.7 Service

- a) **Have your power tool serviced by a qualified repair person using only identical replacement parts.** This will ensure that the safety of the power tool is maintained.
- b) **Never service damaged battery packs.** Service of battery packs should only be performed by the manufacturer or authorized service providers.

25.8 Hedge trimmer safety warnings

Safety instructions for hedge trimmers

- a) **Do not use the hedge trimmer in bad weather conditions, especially when there is a risk of lightning.** This decreases the risk of being struck by lightning.
- b) **Keep all power cords and cables away from cutting area.** Power cords or cables may be hidden in hedges or bushes and can be accidentally cut by the blade.
- c) **Wear ear protection.** Adequate protective equipment will reduce the risk of hearing loss.¹
- d) **Hold the hedge trimmer by insulated gripping surfaces only, because the blade may contact hidden wiring or its own cord.** Blades contacting a "live" wire may make exposed metal parts of the hedge trimmer "live" and could give the operator an electric shock.

¹Sound pressure level > 85 dB(A)

- e) **Keep all parts of the body away from the blade. Do not remove cut material or hold material to be cut when blades are moving.** Blades continue to move after the switch is turned off. A moment of inattention while operating the hedge trimmer may result in serious personal injury.
 - f) **When clearing jammed material or servicing the hedge trimmer, make sure all power switches are off and the battery pack is removed or disconnected.** Unexpected actuation of the hedge trimmer while clearing jammed material or servicing may result in serious personal injury.
 - g) **Carry the hedge trimmer by the handle with the blade stopped and taking care not to operate any power switch.** Proper carrying of the hedge trimmer will decrease the risk of inadvertent starting and resultant personal injury from the blades.
 - h) **When transporting or storing the hedge trimmer, always use the blade cover.** Proper handling of the hedge trimmer will decrease the risk of personal injury from the blades.
- operating the grass shear may result in serious personal injury.
 - f) **When clearing jammed material or servicing the grass shear, make sure the power switch is off and the battery pack is removed or disconnected.** Unexpected actuation of the grass shear while clearing jammed material or servicing may result in serious personal injury.
 - g) **Carry the grass shear by the handle with the blade stopped and taking care not to operate the power switch.** Proper carrying of the grass shear will decrease the risk of inadvertent starting and resultant personal injury from the blades.
 - h) **When transporting or storing the grass shear, always use the blade cover.** Proper handling of the grass shear will decrease the risk of personal injury from the blades.

25.9 Grass shears safety warnings

Safety instructions for grass shears

- a) **Do not use the grass shear in bad weather conditions, especially when there is a risk of lightning.** This decreases the risk of being struck by lightning.
- b) **Keep all power cords and cables away from cutting area.** Power cords or cables may be hidden and can be accidentally cut by the blade.
- c) **Wear ear protection.** Adequate protective equipment will reduce the risk of hearing loss.²
- d) **Hold the grass shear by insulated gripping surfaces only, because the blade may contact hidden wiring.** Blades contacting a "live" wire may make exposed metal parts of the grass shear "live" and could give the operator an electric shock.
- e) **Keep all parts of the body away from the blade. Do not remove cut material or hold material to be cut when blades are moving.** Blades continue to move after the switch is turned off. A moment of inattention while

²Sound pressure level > 85 dB(A)

www.stihl.com



0458-601-0121-D



0458-601-0121-D