

MSA 60.0 C,  
MSA 70.0 C

**STIHL**



2 - 33      Instruction Manual



## Contents

1	Introduction.....	2
2	Guide to Using this Manual.....	2
3	Overview.....	3
4	Safety Precautions.....	4
5	Preparing the Saw for Operation.....	13
6	Charging the Battery, LEDs.....	13
7	Assembling the Saw.....	15
8	Engaging and Disengaging the Chain Brake .....	17
9	Removing and Fitting the Battery.....	17
10	Switching the Saw On/Off.....	17
11	Testing the Chain Saw and Battery.....	18
12	Operating the Saw.....	19
13	After Finishing Work.....	23
14	Transporting.....	23
15	Storing.....	24
16	Cleaning.....	24
17	Maintenance.....	25
18	Repairing.....	26
19	Troubleshooting.....	26
20	Specifications.....	27
21	Bar and Chain Combinations.....	28
22	Spare Parts and Accessories.....	29
23	Disposal.....	29
24	EC Declaration of Conformity.....	29
25	UKCA Declaration of Conformity.....	29
26	General Power Tool Safety Warnings.....	30

## 1 Introduction

Dear Customer,

Thank you for choosing STIHL. We develop and manufacture our quality products to meet our customers' requirements. The products are designed for reliability even under extreme conditions.

STIHL also stands for premium service quality. Our dealers guarantee competent advice and instruction as well as comprehensive service support.

STIHL expressly commit themselves to a sustainable and responsible handling of natural resources. This user manual is intended to help you use your STIHL product safely and in an environmentally friendly manner over a long service life.

We thank you for your confidence in us and hope you will enjoy working with your STIHL product.



Dr. Nikolas Stihl

**IMPORTANT! READ BEFORE USING AND KEEP IN A SAFE PLACE FOR REFERENCE.**

## 2 Guide to Using this Manual

### 2.1 Applicable Documentation

Local safety regulations apply.

- ▶ Read, understand and save the following documents in addition to this instruction manual:
  - Safety notes and precautions for STIHL AK battery.
  - Safety information for STIHL batteries and products with built in batteries:  
[www.stihl.com/safety-data-sheets](http://www.stihl.com/safety-data-sheets)

### 2.2 Warning Notices in Text



- This notice refers to risks which result in serious or fatal injury.
  - ▶ Serious or fatal injuries can be avoided by taking the precautions mentioned.



- This notice refers to risks which **can** result in serious or fatal injury.
  - ▶ Serious or fatal injuries can be avoided by taking the precautions mentioned.

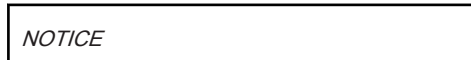

- This notice refers to risks which can result in damage to property.
  - ▶ Damage to property can be avoided by taking the precautions mentioned.

### 2.3 Symbols in Text



This symbol refers to a chapter in this instruction manual.

## 3 Overview

### 3.1 Chainsaw, Battery and Charger

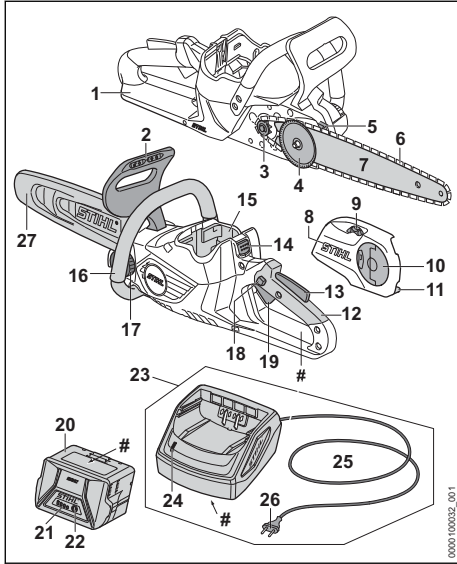

#### 1 Rear hand guard

The rear hand guard protects the right hand against contact with the saw chain if the chain breaks or comes off the bar.

#### 2 Front hand guard

The front hand guard protects the operator's left hand against contact with the saw chain and is used to automatically engage the chain brake in the event of kickback.

#### 3 Chain sprocket

The chain sprocket drives the saw chain.

#### 4 Tensioning gear

The tensioning gear moves the guide bar and thus tensions and slackens the saw chain.

#### 5 Spiked bumper

The spiked bumper supports the chainsaw against the wood while cutting.

#### 6 Saw chain

The saw chain cuts the wood.

#### 7 Guide bar

The guide bar supports and guides the saw chain.

#### 8 Chain sprocket cover

The chain sprocket cover covers the chain sprocket and fastens the guide bar to the chainsaw.

#### 9 Adjusting wheel

The adjusting wheel is used to adjust the chain tension.

#### 10 Wing nut

The wing nut fastens the chain sprocket cover to the chainsaw.

#### 11 Chain catcher

The chain catcher catches the saw chain if it breaks or comes off the bar.

#### 12 Control handle

The control handle is used to control, hold and guide the chainsaw.

#### 13 Ergo lever

The ergo lever holds the locking button in position when the trigger is released.

#### 14 Locking lever

The locking lever holds the battery in the battery compartment.

#### 15 Battery compartment

The battery compartment holds the battery.

#### 16 Handlebar

The handlebar is used to hold, control and carry the chainsaw.

#### 17 Oil tank cap

The oil tank cap closes the oil tank.

#### 18 Locking button

The locking button unlocks the trigger.

#### 19 Trigger

The trigger turns the chainsaw on and off.

#### 20 Battery

The battery supplies the chainsaw with power.

#### 21 LEDs

The LEDs indicate the state of charge of the battery and any faults.

#### 22 Pushbutton

The pushbutton activates the LEDs on the battery.

#### 23 Charger

The charger charges the battery.

#### 24 LED

The LED indicates the status of the charger.

#### 25 Connecting cable

The connecting cable connects the charger to the mains plug.

#### 26 Mains plug

The mains plug connects the connecting cable with a socket















## 27 Chain scabbard

The chain scabbard protects against contact with the saw chain.

## # Rating plate with the machine number

### 3.2 Symbols

Meanings of symbols that may be on the chain-saw, battery and charger:

-  This symbol shows the direction of rotation of the chain.
-  Turn in this direction to tension the saw chain.
-  This symbol marks the chain oil tank.
-  The chain brake is engaged in this direction.
-  The chain brake is disengaged in this direction.
-  1 LED glows red. Battery too hot or too cold.
-  4 LEDs flash red. There is a malfunction in the battery.
-  LED glows green and LEDs on battery glow or flash green. Battery is being charged.
-  LED flashes red. No electrical contact between battery and charger or malfunction in battery or charger.
-  Length of guide bar that may be used.
-  Guaranteed sound power level according to directive 2000/14/EC in dB(A) in order to make sound emissions of products comparable.
-  The data next to this symbol indicates the energy content of the battery according to the cell manufacturer's specification. The energy content available during operation is lower.
-  Operate the electric appliance in a dry place, indoors only.
-  Do not dispose of the product with your household waste.

## 4 Safety Precautions

### 4.1 Warning symbols

Meanings of warning signs and labels on the saw, battery or charger:

-  Observe safety instructions and take the necessary precautions.
-  Read and understand the User Manual and keep it in a safe place.
-  Wear safety glasses and a hard hat.
-  Hold the chainsaw firmly with both hands.
-  Observe the safety notices on kickback and take the necessary precautions.
-  Remove the battery during work interruptions, transport, storage, maintenance or repair.
-  Protect saw and charger from rain and dampness.
-  Protect battery from heat and fire.
-  Protect the battery from rain and moisture and do not immerse it in liquids.

### 4.2 Intended Use

The STIHL MSA 60.0 C or MSA 70.0 C chainsaw is designed for cutting wood, limbing and felling small diameter trees and maintaining trees close to dwellings.

Do not use the chainsaw in the rain.

The STIHL AK battery supplies power to the chainsaw.

The STIHL AL 101 charger is used to charge the STIHL AK battery.

## ▲ WARNING

- Batteries and chargers not explicitly approved for the chainsaw by STIHL may cause a fire or explosion. Persons may be seriously or fatally injured, and property may be damaged.
  - ▶ Use the chainsaw with a STIHL AK battery.

- ▶ Recharge the STIHL AK battery with a STIHL AL 101, AL 301 or AL 500 charger.
- Using the chainsaw, battery or the charger for purposes for which they were not designed may result in serious or fatal injuries, and damage to property may occur.
  - ▶ Use the chainsaw, battery and charger as described in this user manual.

### 4.3 The Operator

#### **▲ WARNING**

- Users without adequate training or instruction cannot recognize or assess the risks involved in using the chainsaw, battery and charger. The user or other persons may sustain serious or fatal injuries.



- ▶ Read, understand and save the instruction manual.

- ▶ If you pass the saw, battery and charger on to another person: Always give them the instruction manual.
- ▶ Make sure the user meets the following requirements:
  - The user must be rested.
- The user must be in good physical condition and mental health to operate and work with the saw, battery and charger. If the user's physical, sensory or mental ability is restricted, he or she may work only under the supervision of or as instructed by a responsible person.
  - The user is able to recognize and assess the risks involved in using the chainsaw, battery and charger.
- The user must be of legal age or is being trained in a trade under supervision in

accordance with national rules and regulations.

- The user has received instruction from a STIHL servicing dealer or other experienced user before working with the chainsaw and using the charger for the first time.
  - The user must not be under the influence of alcohol, medication or drugs.
- ▶ If the user is working with a chainsaw for the first time: Practice cutting logs on a sawhorse or other support.
- ▶ If you have any queries: Contact a STIHL servicing dealer for assistance.

### 4.4 Clothing and equipment

#### **▲ WARNING**

- Long hair may be pulled into the chainsaw while working. This may result in serious injury to the user.
  - ▶ Tie up and confine long hair above your shoulders.
- Objects can be thrown at high speed during operation. This may result in injury to the user.
  - ▶ Wear close-fitting safety glasses. Suitable safety glasses are tested in accordance with EN 166 or national regulations and available commercially with the corresponding marking.
  - ▶ STIHL recommends wearing a face mask.
  - ▶ Wear a long-sleeved, close fitting top.
- Falling objects can cause head injuries.
  - ▶ If objects are likely to fall while working: wear a hard hat.
- Dust can be whipped up during operation: Whipped up dust can damage the respiratory passages and cause allergic reactions.
  - ▶ If dust is whipped up or forms a cloud: Wear a dust respirator mask.
- Unsuitable clothing can snag on wood or scrub and may become caught in the chain saw. Users not wearing suitable clothing are at risk of serious injury.
  - ▶ Wear close-fitting clothing.
  - ▶ Remove scarves and jewelry.



- The user may come into contact with the moving saw chain while working. This may result in serious injury to the user.
  - ▶ Wear long trousers with cut protection.
- The user may cut himself or herself on wood while working. The user may come into contact with the saw chain during cleaning or servicing. This may result in injury to the user.
  - ▶ Wear work gloves made from resistant material.
- Wearing unsuitable footwear may cause the user to slip. If the user comes into contact with the moving saw chain, he or she may suffer cuts. This may result in injury to the user.
  - ▶ Wear chainsaw boots with cut protection.

## 4.5 Work Area and Surroundings

### 4.5.1 Chainsaw

#### **▲ WARNING**

- Bystanders, children and animals are not aware of the dangers of the chainsaw or thrown objects. Innocent bystanders, children and animals may be seriously injured and damage to property may occur.
  - ▶ Keep bystanders, children and animals away from the work area.
  - ▶ Do not leave the chainsaw unattended.
  - ▶ Make sure that children cannot play with the chainsaw.
- The saw is not waterproof. Working in the rain or a damp location may result in an electric shock. This can result in injuries to the user and may damage the chainsaw.



- ▶ Do not work in the rain or a damp location.

- Electrical components of the chainsaw can produce sparks. Sparks may cause a fire or an explosion in an easily combustible or explosive environment. This can result in serious or fatal injuries and damage to property.
  - ▶ Do not work in an easily combustible or explosive environment.

### 4.5.2 Battery

#### **▲ WARNING**

- Bystanders, children and animals cannot recognize or assess the dangers of the battery. Bystanders, children and animals may be seriously injured.
  - ▶ Keep bystanders, children and animals away from the work area.
  - ▶ Do not leave the battery unattended.

- ▶ Make sure that children cannot play with the battery.
- The battery is not protected against all ambient conditions. If the battery is exposed to certain ambient conditions, the battery may catch fire, explode or be irreparably damaged. This may result in serious injury to people and damage to property.



- ▶ Protect battery from heat and fire.
- ▶ Do not throw the battery into a fire.

- ▶ Do not charge, use and store the battery outside of the specified temperature limits, **20.7**.



- ▶ Protect the battery from rain and moisture and do not immerse it in liquids.

- ▶ Keep battery away from small metal parts.
- ▶ Do not expose the battery to high pressure.
- ▶ Do not expose the battery to microwaves.
- ▶ Protect the battery from chemicals and salts.

### 4.5.3 Charger

#### **▲ WARNING**

- Bystanders and children are not aware of and cannot assess the dangers of a charger or electric current. Bystanders, children and animals may be seriously or fatally injured.
  - ▶ Keep bystanders, children and animals away from the work area.
- ▶ **Make sure that children cannot play with the charger.**
- The charger is not waterproof. If you work in the rain or in a damp environment, an electric shock may occur. The user may be injured and the charger may be damaged.



- ▶ Do not operate it in the rain or in a damp environment.

- The charger is not protected against all ambient conditions. If the charger is exposed to certain ambient conditions, it may catch fire or explode. This may result in serious injury to people and damage to property.
  - ▶ Operate the charger in an enclosed, dry room.
  - ▶ Do not operate the charger in a flammable environment or in an explosive environment.
  - ▶ Do not operate the charger on a readily combustible surface.

- ▶ Do not use and store the charger outside of the specified temperature limits,  20.7.
- The connecting cable is a trip hazard. People may be injured and the charger may be damaged.
  - ▶ Lay the connecting cable flat on the floor.

## 4.6 Safe Condition

### 4.6.1 Chainsaw

The chainsaw is in a safe condition if the following points are observed:

- The chainsaw is not damaged.
- The saw is clean and dry.
- The chain catcher is not damaged.
- The chain brake is operating properly.
- The controls function properly and have not been modified.
- The chain lubrication is operating properly.
- Wear marks on the chain sprocket are not deeper than 0.5 mm.
- A combination of guide bar and saw chain recommended in this User Manual is mounted.
- The guide bar and saw chain are properly mounted.
- The saw chain is properly tensioned.
- Only original STIHL accessories designed for this chainsaw model are fitted.
- The accessories are correctly attached.
- The oil tank cap is closed.

### WARNING

- If not in safe condition, components may no longer operate correctly and safety devices may be disabled. This may result in serious or fatal injury to people.
  - ▶ Work only with an undamaged chainsaw.
  - ▶ If the saw is dirty or wet: Clean the saw and allow it to dry.
  - ▶ Work only with an undamaged chain catcher.
  - ▶ Never modify your chainsaw. Exception: Mounting a combination of guide bar and saw chain recommended in this User Manual.
  - ▶ If the controls do not function properly: Do not use your chainsaw.
  - ▶ Only fit original STIHL accessories designed for this chainsaw model.
  - ▶ Mount the guide bar and saw chain as described in this User Manual.
  - ▶ Attach accessories as described in this User Manual or in the User Manual for the accessories.
  - ▶ Never insert objects in the chainsaw's openings.

- ▶ Close the oil tank cap.
- ▶ Replace worn or damaged labels.
- ▶ If you have any doubts, be sure to consult a STIHL dealer.

### 4.6.2 Guide Bar

The guide bar is in a safe condition if the following points are observed:

- Guide bar is not damaged.
- Guide bar is not deformed.
- The minimum groove depth is maintained,  20.3.
- Bar rails are free from burrs.
- Bar groove is not pinched or splayed.

### WARNING

- If the guide bar is not in a safe condition, it can no longer support and guide the saw chain properly. The rotating saw chain can jump off the guide bar. This can result in serious or fatal injuries.
  - ▶ Work only with an undamaged guide bar.
  - ▶ If the groove depth is less than the minimum depth: Mount a new guide bar.
  - ▶ Deburr the guide bar every week.
  - ▶ If you have any queries: Contact your STIHL servicing dealer.

### 4.6.3 Saw Chain

The saw chain is in a safe condition if the following points are observed:

- Chain is not damaged.
- Chain is properly sharpened.
- The service marks on the cutters are still visible.

### WARNING

- If components do not comply with safety requirements, they will no longer function properly and safety devices may be rendered inoperative. This can result in serious or fatal injuries.
  - ▶ Work only with an undamaged saw chain.
  - ▶ Sharpen the chain properly.
  - ▶ If you have any queries: Contact your STIHL servicing dealer for assistance.

### 4.6.4 Battery

The battery is in a safe condition if the following points are observed:

- Battery is undamaged.
- The battery is clean and dry.
- Battery functions properly and has not been modified.



## **▲ WARNING**

- A battery that is not in a safe condition cannot operate safely. Persons may be seriously injured.
  - ▶ Never work with a damaged battery.
  - ▶ Never attempt to charge a damaged or defective battery.
  - ▶ If the battery is dirty: Clean the battery.
  - ▶ If the battery is wet or damp: Allow the battery to dry, **☑** 20.8.
  - ▶ Never attempt to modify the battery.
  - ▶ Never insert objects in the battery's openings.
  - ▶ Never bridge the battery's contacts with metallic objects (short circuit).
  - ▶ Do not open the battery.
  - ▶ Replace worn or damaged labels.
- Fluid may leak from a damaged battery. If that liquid comes into contact with the skin or eyes, the skin or eyes may be irritated.
  - ▶ Avoid contact with the liquid.
  - ▶ If skin contact occurs: Wash affected areas of skin with plenty of water and soap.
  - ▶ In the event of contact with eyes: Rinse eyes with plenty of water for at least 15 minutes and consult a doctor.
- A damaged or defective battery may smell unusual, emit smoke or burn. Persons may be seriously or fatally injured, and property may be damaged.
  - ▶ If the battery smells unusual or emits smoke: do not use the battery and keep it away from combustible substances.
  - ▶ If the battery catches fire: Attempt to extinguish the battery with a fire extinguisher or water.

### **4.6.5 Charger**

The charger is in a safe condition if the following points are observed:

- Charger is undamaged.
- Charger is clean and dry.

## **▲ WARNING**

- If components do not comply with safety requirements, they will no longer function properly and safety devices may be rendered inoperative. This can result in serious or fatal injuries.
  - ▶ Do not use a damaged charger.
  - ▶ If the charger is dirty or wet: Clean the charger and allow it to dry.
  - ▶ Never attempt to modify the charger.
  - ▶ Never insert objects in the charger's openings.

- ▶ Never bridge the charger's contacts with metallic objects (short circuit).
- ▶ Do not open the charger.

## **4.7 Working**

### **4.7.1 Cutting**

## **▲ WARNING**

- Always work within calling distance of others in case help is needed.
  - ▶ Make sure than persons outside the work area are within calling distance.
- The user cannot concentrate on the work in certain situations. The user can lose control of the saw, stumble or fall and be seriously injured.
  - ▶ Work calmly and carefully.
  - ▶ If light and visibility are poor: Do not use your saw.
  - ▶ Operate the chainsaw alone.
  - ▶ Do not work above shoulder height.
  - ▶ Watch out for obstacles.
  - ▶ Stand on the ground while working and keep a good balance. If it is necessary to work at heights: Use a lift bucket or a safe platform.
  - ▶ If you begin to feel tired: Take a break.
- The rotating saw chain can cut the operator. This can result in serious injuries.
  - ▶ Do not touch the rotating saw chain.
  - ▶ If the saw chain is blocked by an object: Switch off the chainsaw, engage the chain brake and remove the battery. Then remove the object causing the blockage.
- The rotating chain becomes hot and expands. If the chain is not lubricated sufficiently or not re-tensioned at regular intervals, it may come off the guide bar or break. This can result in serious injuries and damage to property.
  - ▶ Use special chain oil.
  - ▶ Check oil level in tank regularly during cutting work. Before the oil tank runs empty: Fill up with chain oil.
  - ▶ Check chain tension regularly during cutting work. If chain tension is insufficient: Tension the chain.
- If the behavior of the saw changes during operation or feels unusual, it may no longer be in a safe condition. This can result in serious injuries and damage to property.
  - ▶ Stop work, remove the battery and contact your STIHL servicing dealer for assistance.
- Saw vibrations may occur during operation.
  - ▶ Wear gloves.
  - ▶ Take regular breaks.



- ▶ If signs of circulation problems occur: Seek medical advice.
- Sparks may occur if the rotating chain makes contact with a hard object. Sparks may cause a fire in an easily combustible location. This can result in serious or fatal injuries and damage to property.
  - ▶ Do not work in an easily combustible location.
- Note that the saw chain continues to rotate for a short period after you release the trigger. The rotating saw chain can cut the user. This can result in serious injuries.
  - ▶ Wait for the chain to come to a standstill.

## ▲ WARNING

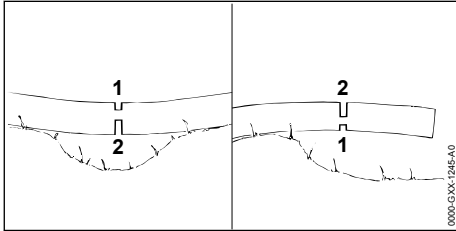

- The guide bar can be pinched when cutting wood that is under tension. The user can lose control of the saw and be seriously injured.
  - ▶ Make a relieving cut in the compression side (1) first, then perform bucking cut at the tension side (2).

## ▲ DANGER

- Working near live electric cables can result in accidental contact with the chain and damage the cables. This can result in serious or fatal injuries.
  - ▶ Do not work near live electric cables.

### 4.7.2 Limbing

## ▲ WARNING

- If the underside of the felled tree is limbed first, it will no longer be supported on the ground by branches. The tree can move during cutting work. This can result in serious or fatal injuries.
  - ▶ Cut through large limbs on the underside of the tree only after it has been bucked.
  - ▶ Do not stand on the log while limbing it.
- A branch may fall to the ground during limbing. The user may trip, fall or be seriously injured.
  - ▶ Limb from the base to the crown of the tree.

### 4.7.3 Felling

## ▲ WARNING

- Inexperienced users cannot assess the dangers when felling a tree. Persons may be seriously or fatally injured and property may be damaged.
  - ▶ The user needs relevant knowledge of felling technology and experience of felling work.
  - ▶ If anything is unclear, consult an experienced expert for assistance and to determine the appropriate felling technique.
- A tree and branches can fall on bystanders or objects during felling. The larger the falling parts are, the greater the risk of serious or fatal injury to people. Damage to property may occur.
  - ▶ Determine direction of fall so that the area in which the tree falls is clear.
  - ▶ Do not allow bystanders, children or animals within 2.5 tree lengths of the work area.
  - ▶ Remove broken or dead branches from the tree crown before felling.
  - ▶ If bent or withered branches cannot be removed from the tree crown, consult an experienced expert for assistance and to determine the appropriate felling technique.
  - ▶ Be aware of the tree crown and crowns of neighboring trees, and keep clear of falling branches.
- When the tree falls the trunk could break or spring back in the direction of the user. This may result in serious or fatal injury to the user.
  - ▶ Plan a sideways escape path behind the tree.
  - ▶ Walk backwards along the escape path and observe the falling tree.
  - ▶ Do not walk backwards down slopes.
- Obstacles in the work area and on the escape path can hinder the user. The user may trip and fall. This may result in serious or fatal injury to the user.
  - ▶ Remove all obstacles from the work area and escape path.
- If you cut into or through the hinge, stabilizing strap or holding strap too soon, the intended direction of fall cannot be controlled or the tree may fall prematurely. Persons may be seriously or fatally injured and property may be damaged.
  - ▶ Do not cut into or through the hinge.
  - ▶ Cut through the stabilizing strap or holding strap last.

- ▶ If the tree begins to fall too soon: Abandon the felling cut and retreat along the escape path.
- Kickback can occur if the rotating chain in the upper quadrant of the bar nose makes contact with a hard felling wedge and is suddenly braked. There is a risk of serious or fatal injury.
  - ▶ Use aluminum or plastic felling wedges.
- If the tree does not fall all the way to the ground or gets caught on another tree, the operator cannot finish the operation in a controlled manner.
  - ▶ Stop the felling operation and use a cable winch or suitable vehicle to pull the tree to the ground.

## 4.8 Reactive Forces

### 4.8.1 Kickback

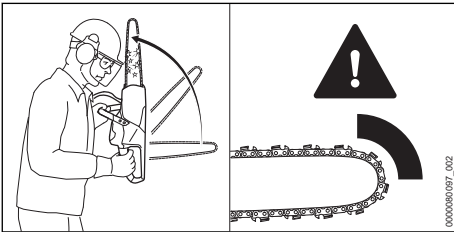

Kickback can be caused for the following reasons:

- The rotating saw chain in the upper quadrant of the bar nose makes contact with a hard object and is suddenly braked.
- The rotating saw chain is pinched at the bar nose.

The chain brake cannot prevent kickback.

### ▲ WARNING

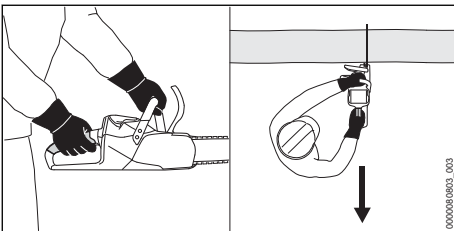

- If kickback occurs, the saw can be thrown up in the direction of the operator. The operator can lose control of the saw and be seriously or fatally injured.
  - ▶ Hold the saw firmly with both hands.
  - ▶ Always keep your body out of the plane of the cutting attachment.

- ▶ Operate the saw as described in this instruction manual.
- ▶ Do not cut with the upper quadrant of the bar nose.
- ▶ Always cut with a properly sharpened and tensioned saw chain.
- ▶ Use a reduced kickback saw chain.
- ▶ Use a guide bar with a narrow radius nose.
- ▶ Always cut with the chain running at full speed.

### 4.8.2 Pull-in

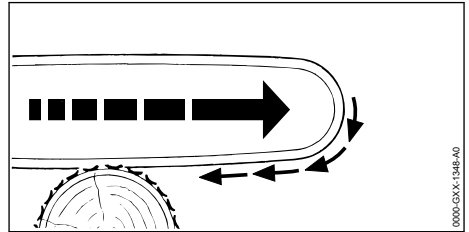

The saw is pulled away from the operator when the bottom of the bar is used for cutting.

### ▲ WARNING

- If the rotating chain makes contact with a hard object and is suddenly pinched, the saw is abruptly jerked away from the operator. The operator can lose control of the saw and be seriously or fatally injured.
  - ▶ Hold the saw firmly with both hands.
  - ▶ Operate the saw as described in this instruction manual.
  - ▶ Keep the guide bar straight in the cut.
  - ▶ Apply the spiked bumper properly.
  - ▶ Always cut with the chain running at full speed.

### 4.8.3 Pushback

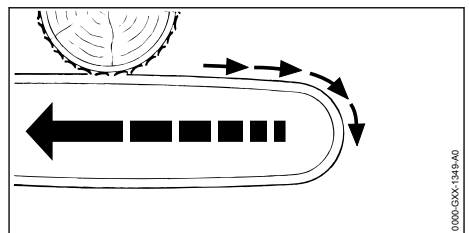

The saw is pushed back toward the operator when the top of the bar is used for cutting.

### ▲ WARNING

- If the rotating chain makes contact with a hard object and is suddenly pinched, the saw can

be abruptly pushed back toward the operator. The operator can lose control of the saw and be seriously or fatally injured.

- ▶ Hold the saw firmly with both hands.
- ▶ Operate the saw as described in this instruction manual.
- ▶ Keep the guide bar straight in the cut.
- ▶ Always cut with the chain running at full speed.

## 4.9 Charging

### ▲ WARNING

- A damaged or defective charger may produce an unusual smell or emit smoke during the charging process. This may result in personal injuries and damage to property.
  - ▶ Disconnect the plug from the wall outlet.
- The charger can overheat and cause a fire if heat dissipation is inadequate. This can result in serious or fatal injuries and damage to property.
  - ▶ Do not cover the charger.

## 4.10 Connecting to the power supply

Contact with live components may occur for the following reasons:

- The connecting cable or the extension cord is damaged.
- The mains plug of the connecting cable or extension cord is damaged.
- The socket is not properly installed.

### ▲ DANGER

- Contact with live parts may result in electric shock. This may result in serious or fatal injury to the user.
  - ▶ Make sure that the connecting cable, extension cord and their mains plugs are undamaged.



If the connecting cable or the extension cord is damaged:

- ▶ Do not touch the damaged area.
- ▶ Disconnect the mains plug from the power supply.
- ▶ Make sure your hands are dry before touching the connecting cable, extension cord or mains plugs.
- ▶ Plug the mains plug of the connecting cable or extension cord into a properly installed, shockproof socket with the correct fuse rating.
- ▶ Install the charger with a ground fault circuit interrupter (30 mA, 30 ms).

- A damaged or unsuitable extension cable can result in electric shock. There is a risk of serious or fatal injury.
  - ▶ Use an extension cable with the correct cable cross-section, 20.6.

### ▲ WARNING

- Overvoltage can occur in the charger if the line voltage or frequency are incorrect during charging. The charger may be damaged.
  - ▶ Make sure that the mains voltage and the mains frequency of the power supply match the data on the rating plate of the charger.
- If the charger is connected to a power strip, electrical components may be overloaded during the charging process. The components may overheat and cause a fire. Persons may be seriously or fatally injured, and property may be damaged.
  - ▶ Ensure that the technical specifications for the power strip are not exceeded by the information on the rating plate of the charger and of all electrical devices connected to the power strip.
- An incorrectly routed connecting cable or extension cord may be damaged, and people may trip over it. People may be injured, and the connecting cable or extension cord may be damaged.
  - ▶ Route and mark the connecting cable and extension cord so that people will not trip over them.
  - ▶ Route the connecting cable and extension cord so that they are not under tension or tangled.
  - ▶ Route the connecting cable and extension cord so that they will not be damaged, kinked or crushed and will not be chafed.
  - ▶ Protect the connecting cable and extension cord from heat, oil and chemicals.
  - ▶ Lay the connecting cable and extension cord on a dry surface.
- The extension cable warms up in operation. If that heat cannot escape, it may cause a fire.
  - ▶ If using a cable reel: completely unroll the cable reel.
- If wiring and pipes are laid in the wall, they may be damaged if the charger is mounted on the wall. Contact with wiring can result in electric shock. This may result in serious injury to people and damage to property.
  - ▶ Make sure there is no wiring or pipes in the wall at the proposed mounting site.
- If the charger is not mounted on the wall as described in this User Manual, the charger or the battery may fall or the charger may over-

heat. This may result in injury to people and damage to property.

- ▶ Mount the charger on a wall as described in this User Manual.
- If the charger is mounted on a wall with the battery inserted, the battery may fall out of the charger. This may result in injury to people and damage to property.
  - ▶ Mount the charger on the wall first before inserting the battery.

## 4.11 Transporting

### 4.11.1 Chainsaw

#### ⚠ WARNING

- The saw may turn over or shift during transport. This may result in personal injuries and damage to property.



- ▶ Remove the battery.

- ▶ Engage the chain brake.
- ▶ Fit the scabbard so that it completely covers the guide bar.
- ▶ Secure the chainsaw with lashing straps or a net to prevent it turning over and moving.

### 4.11.2 Battery

#### ⚠ WARNING

- The battery is not protected against all ambient conditions. The battery may be damaged if it is exposed to certain ambient conditions, and damage to property may occur.
  - ▶ Never transport a damaged battery.
- The battery may turn over or shift during transport. This may result in injury to people and damage to property.
  - ▶ Pack the battery in packaging in such a way that it cannot move.
  - ▶ Secure the packaging so that it cannot move.

### 4.11.3 Charger

#### ⚠ WARNING

- The charger may turn over or move while being transported. This may result in personal injuries and damage to property.
  - ▶ Disconnect the plug from the wall outlet.
  - ▶ Remove the battery.
  - ▶ Secure the charger with lashing straps, belts or a net to prevent it turning over and moving.

- The connecting cable must not be used for carrying the charger. The connecting cable and the charger may be damaged.
  - ▶ Wind up the connecting cable and attach it to the charger.

## 4.12 Storing

### 4.12.1 Chainsaw

#### ⚠ WARNING

- Children are not aware of and cannot assess the dangers of a chainsaw and can be seriously injured.



- ▶ Remove the battery.

- ▶ Engage the chain brake.
- ▶ Fit the scabbard so that it completely covers the guide bar.
- ▶ Store the saw out of the reach of children.
- Dampness can corrode the electrical contacts on the saw and metal components. This can damage the saw.



- ▶ Remove the battery.

- ▶ Store the saw in a clean and dry condition.

### 4.12.2 Battery

#### ⚠ WARNING

- Children are not aware of and cannot assess the dangers of the battery. Children may be seriously injured.
  - ▶ Store the battery out of the reach of children.
- The battery is not protected against all ambient conditions. If the battery is exposed to certain ambient conditions, the battery may be irreparably damaged.
  - ▶ Store the battery in a clean and dry condition.
  - ▶ Store the battery in an enclosed space.
  - ▶ Store the battery separately from the chainsaw.
  - ▶ If the battery is stored in the charger, disconnect the mains plug and store the battery at a state of charge between 40% and 60% (2 lit green LEDs).
  - ▶ Do not store the battery outside of the specified temperature limits, 20.7.

### 4.12.3 Charger

## ▲ WARNING

- Children are not aware of and cannot assess the dangers of a charger. Children can be seriously injured or killed.
  - ▶ Disconnect the plug from the wall outlet.
  - ▶ Store the charger out of reach of children.
- The charger is not protected against all ambient conditions. If the charger is exposed to certain ambient conditions, the charger may be damaged.
  - ▶ Disconnect the plug from the wall outlet.
  - ▶ If the charger is hot: Allow the charger to cool down.
  - ▶ Store the charger in a clean, dry place.
  - ▶ Store the charger in an enclosed room.
  - ▶ Do not store the charger outside of the specified temperature limits, [10](#) 20.7.
- The connecting cable should not be used for carrying the charger or hanging up the charger. The connecting cable and the charger may be damaged.
  - ▶ Hold the charger by the housing in a secure grip. The charger is provided with a handle recess to make it easy to pick up the charger.
  - ▶ Hang the charger on the wall mounting.

## 4.13 Cleaning, Maintenance and Repair

## ▲ WARNING

- The saw may start unintentionally if the battery is left in place during cleaning, maintenance or repair operations. This may result in serious injury to people and damage to property.
  - ▶ Remove the battery.



- ▶ Engage the chain brake.
- Aggressive cleaning agents, a water jet or pointed objects can damage the chainsaw, guide bar, the saw chain, the battery and the charger. If the saw, guide bar, saw chain, battery or charger are not cleaned correctly, components may no longer function properly or safety devices may be rendered inoperative. They may cause serious injury to persons.
  - ▶ Clean the saw, guide bar, saw chain, battery and charger as described in this instruction manual.
- If the saw, guide bar, saw chain, battery or charger are not properly serviced, components may no longer function properly or safety devices

- may be rendered inoperative. This may result in serious or fatal injury to people.
  - ▶ Do not attempt to service or repair the saw, battery or charger.
  - ▶ If the saw, battery or the charger require servicing or repairs: Contact your STIHL servicing dealer for assistance.
  - ▶ Service or repair the guide bar and saw chain as described in this User Manual.
- The user may be cut by the sharp cutters while cleaning or servicing the saw chain. This may result in injury to the user.
  - ▶ Wear work gloves made from resistant material.

## 5 Preparing the Saw for Operation

### 5.1 Preparing the Saw for Operation

Perform the following steps before starting work:

- ▶ Make sure the following components are in a safe condition:
  - Chain saw, [10](#) 4.6.1.
  - Guide bar, [10](#) 4.6.2.
  - Saw chain, [10](#) 4.6.3.
  - Battery, [10](#) 4.6.4.
  - Charger, [10](#) 4.6.5.
- ▶ Check the battery, [10](#) 11.7.
- ▶ Fully charge the battery, [10](#) 6.2.
- ▶ Clean the saw, [10](#) 16.1.
- ▶ Mount the bar and chain, [10](#) 7.1.1.1.
- ▶ Tension the saw chain, [10](#) 7.2.
- ▶ Fill up with chain oil, [10](#) 7.3.
- ▶ Check the chain brake, [10](#) 11.4.
- ▶ Check the controls, [10](#) 11.5.
- ▶ Check chain lubrication, [10](#) 11.6.
- ▶ If you cannot carry out this work: Do not use your chain saw and contact your STIHL servicing dealer.

## 6 Charging the Battery, LEDs

### 6.1 Mounting the Charger on a Wall

The charger can be mounted on a wall.

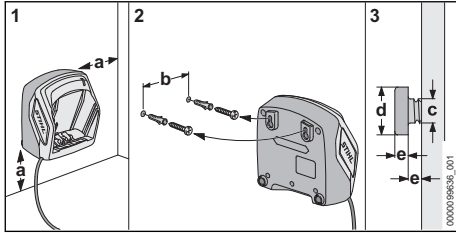

► Check the following points when mounting the charger on a wall:

- Suitable fixing materials.
- The charger is level.
- The following dimensions are observed:
  - a = at least 100 mm
  - b (for AL 101) = 75 mm
  - b (for AL 301) = 100 mm
  - b (for AL 500) = 120 mm
  - c = 4.5 mm
  - d = 9 mm
  - e = 2.5 mm

## 6.2 Charging the Battery

The charging time depends on various factors, e.g. the battery temperature or the ambient temperature. For optimum performance, observe the recommended temperature ranges, 20.8. The actual charging time may vary from the charging time indicated. The charging time is indicated at [www.stihl.com/charging-times](http://www.stihl.com/charging-times).

The charging process starts automatically when the mains plug is plugged into a socket and the battery is inserted into the charger. The charger switches off automatically when the battery is fully charged.

The battery and the charger warm up during charging.

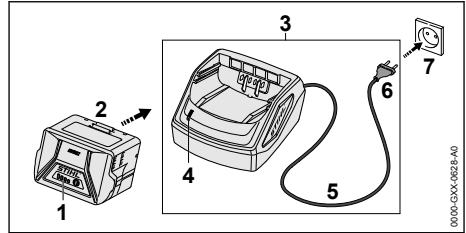

- Plug the mains plug (6) into an easily accessible socket (7). The charger (3) will run a self-test. The LED (4) will glow green for about 1 second and red for about 1 second.
- Routing the connecting cord (5).
- Insert the battery (2) in the guides in the charger (3) and press it home as far as stop. The LED (4) glows green. The LEDs (1) glow green and the battery (2) is being charged.
- When the LED (4) and the LEDs (1) on the battery no longer light up: The battery (2) is fully charged and can be removed from the charger (3).
- If the charger (3) is no longer required. Disconnect the mains plug (6) from the wall outlet (7).

## 6.3 State of Charge

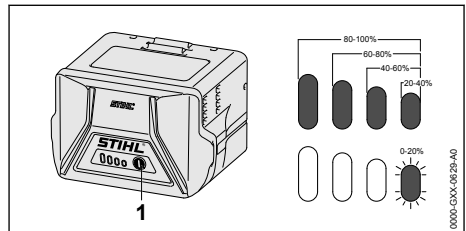

- Press the button (1). The LEDs (5) glow green for about 5 seconds and indicate the state of charge.
- If the LED on the right flashes green: Charge the battery.

## 6.4 LEDs on Battery

The LEDs can show the state of charge or malfunctions. The LEDs can glow or flash green or red.

The state of charge is indicated when the LEDs glow or flash green.

- If the LEDs glow or flash red: Troubleshooting, 19. Malfunction in chainsaw or battery.

## 6.5 LED on Charger

The LED indicates the operating status of the charger.

If the LED glows green, the battery is being charged.

- ▶ If the LED flashes red: Rectify the malfunction. Malfunction in charger.

## 7 Assembling the Saw

### 7.1 Mounting and Removing the Bar and Chain

#### 7.1.1 Mounting the Bar and Chain

The bar and chain combinations that can be used with the chain sprocket are listed in the specifications, **21**.

- ▶ Switch off the chain saw, engage the chain brake and remove the battery.

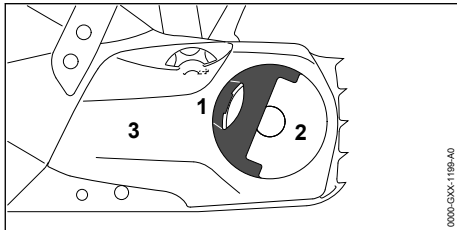

- ▶ Raise the grip (1) of the wingnut (2).
- ▶ Rotate the wingnut (2) counterclockwise until the chain sprocket cover (3) can be removed.
- ▶ Remove the chain sprocket cover (3).

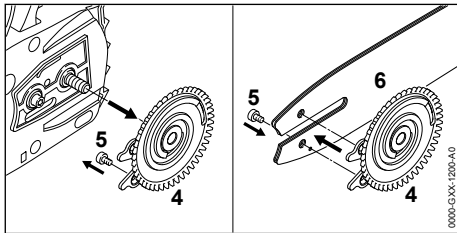

- ▶ Remove the tensioning gear (4).
- ▶ Take out the screw (5).
- ▶ Place the guide bar (6) on the tensioning gear (4) so that both pegs on the tensioning gear (4) engage the holes in the guide bar.

The guide bar (6) may be either way round. The logo on the guide bar may also be upside down.

- ▶ Insert and tighten down the screw (5).

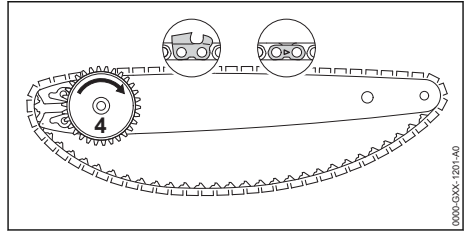

- ▶ Fit the chain in the bar groove so that the arrows on the tie straps on top of the bar point in the direction of rotation.
- ▶ Turn the tensioning gear (4) clockwise as far as stop.

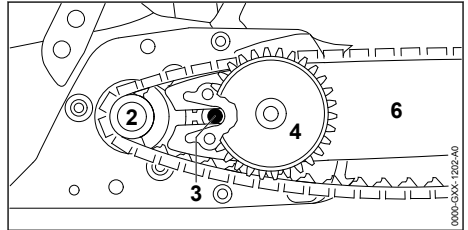

- ▶ Fit the guide bar with tensioning gear and chain on the saw and check the following points:
  - The tensioning gear (4) faces the user.
  - Chain drive links are seated in teeth of chain sprocket (2).
  - Head of screw (3) locates in slot in guide bar (6).

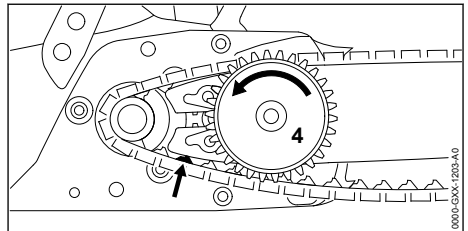

- ▶ Disengage the chain brake.
- ▶ Rotate the tensioning gear (4) counterclockwise until the chain fits snugly against the bar. Make sure the drive link tangs engage the bar groove. The guide bar and chain are positioned against the saw.
- ▶ Fit the sprocket cover so that it is flush with the saw.



- ▶ If the sprocket cover is not flush with the saw: Turn the adjusting wheel slightly and refit the sprocket cover. The teeth of the adjusting wheel and tensioning gear must mesh.
- ▶ Rotate the wingnut clockwise until the chain sprocket cover is firmly seated.
- ▶ Fold down the grip of the wingnut.

### 7.1.2 Removing the Bar and Chain

- ▶ Switch off the chain saw, engage the chain brake and remove the battery.
- ▶ Raise the grip of the wingnut.
- ▶ Rotate the wingnut counterclockwise until the chain sprocket cover can be removed.
- ▶ Remove the sprocket cover.
- ▶ Turn the tensioning gear clockwise as far as stop. The chain is now slack.
- ▶ Remove the bar and chain.
- ▶ Take out the screw in the tensioning gear.
- ▶ Remove the tensioning gear.

## 7.2 Tensioning the Saw Chain

The saw chain expands or contracts during cutting work. Chain tension changes as a result. Check chain tension regularly during operation and readjust if necessary.

- ▶ Switch off the chainsaw, engage the chain brake and remove the battery.

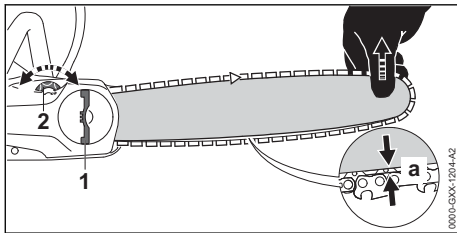

- ▶ Raise the grip of the wingnut (1).
- ▶ Rotate the wingnut (1) two turns counterclockwise. The wingnut (1) is loose.
- ▶ Disengage the chain brake.
- ▶ Hold the bar nose up and turn the tensioning screw (2) clockwise or counterclockwise until the following points apply:
  - Chain sag 'a' in the center of the bar is 1 - 2 mm.
  - The chain can still be pulled easily along the bar with two fingers.
- ▶ If a Carving guide bar is used: Turn the tensioning screw (2) clockwise or counterclockwise until the drive links on the underside of the bar are just half visible.

- ▶ While still holding the bar nose up, rotate the wingnut (1) clockwise until the chain sprocket cover is firmly seated.
- ▶ If chain sag 'a' in the center of the bar is not 1 - 2 mm: Readjust chain tension.
- ▶ If you use a Carving bar and the drive links on the underside of the bar are less than half visible: Readjust chain tension.
- ▶ Fold down the grip of the wingnut (1).

## 7.3 Filling Up with Saw Chain Oil

The saw chain oil lubricates and cools the rotating chain.

STIHL recommends you use a STIHL saw chain oil or an equivalent chain oil approved for chainsaws.

- ▶ switch off chain saw, engage chain brake and remove battery
- ▶ Place your chainsaw on a level surface so that the oil tank cap faces up.
- ▶ Use a damp cloth to clean the oil tank cap and the area around it.

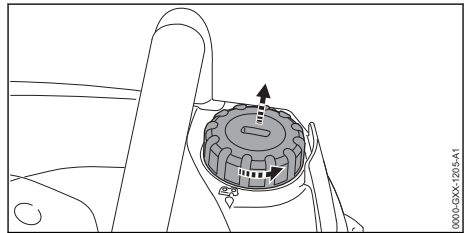

- ▶ With a suitable tool, turn the oil tank cap counterclockwise until it can be removed.
- ▶ Remove the oil tank cap.
- ▶ Fill up with saw chain oil, taking care not to spill any oil and not to overfill the tank.

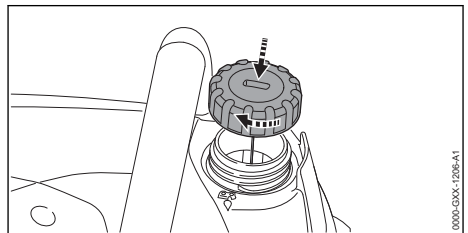

- ▶ Place the oil tank cap on the tank opening.
- ▶ With a suitable tool, turn the oil tank cap clockwise and tighten it down firmly. The oil tank is closed.

## 8 Engaging and Disengaging the Chain Brake

### 8.1 Engaging the Chain Brake

The saw is equipped with a chain brake.

The chain brake is activated by the inertia of the front hand guard if the kickback force is high enough or can be engaged by the operator.

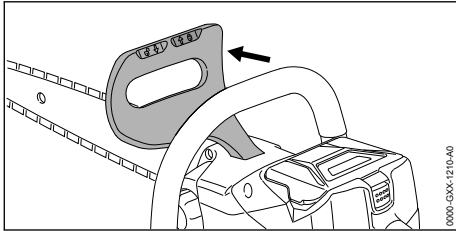

- ▶ Push the hand guard away from the handlebar with your left hand. The hand guard engages with an audible click. The chain brake is engaged.

### 8.2 Disengaging the Chain Brake

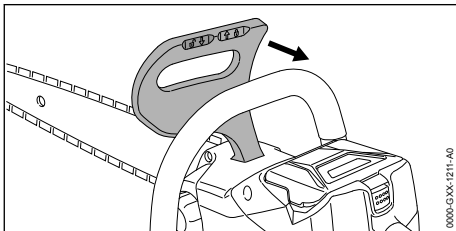

- ▶ Pull the hand guard toward the handlebar with your left hand. The hand guard engages with an audible click. The chain brake is disengaged.

## 9 Removing and Fitting the Battery

### 9.1 Fitting the Battery

- ▶ Engage the chain brake.

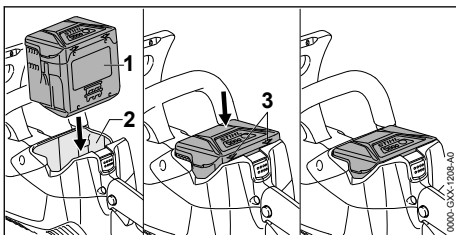

- ▶ Insert the battery (1) in the battery compartment (2) and press it home until you hear a click. Arrows (3) on battery (1) are still visible and battery (1) is held securely in battery compartment (2). There is no electrical contact between the saw and battery (1).
- ▶ Push the battery (1) into the battery compartment (2) as far as stop. The battery (1) engages with a second click and is flush with the saw's housing.

### 9.2 Removing the battery

- ▶ Stand the saw on a level surface.

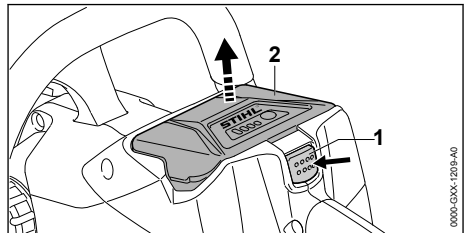

- ▶ Press the locking lever (1). The battery (2) is unlocked and can be removed.

## 10 Switching the Saw On/Off

### 10.1 Turning on the Chainsaw

- ▶ Hold the chain saw by the control handle with your right hand, wrapping your thumb around the control handle.
- ▶ Disengage the chain brake.
- ▶ Hold the chain saw by the handlebar with your left hand, wrapping your thumb around the handlebar.

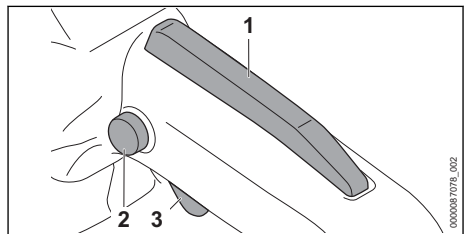

- ▶ Press and hold the lockout button (2) with your thumb.
- ▶ Press the trigger (3) with your index finger and keep it depressed. The chain saw accelerates and the chain starts moving. Release the locking button (2).

The more you depress the trigger (3), the faster the saw chain runs.

If the ergo lever (1) is pressed, the trigger switch (3) remains unlocked. This means the trigger can be released and depressed again without having to press the locking button again.

If the trigger switch (3) and the ergo lever (1) are released, the trigger switch (3) is locked. The locking button (2) must be pressed again and held to unlock the trigger (3).

## 10.2 Switching Off

- ▶ Release the trigger.
  - The chain stops rotating.
- ▶ If the chain continues to rotate: Engage the chain brake, remove the battery and contact your STIHL servicing dealer for assistance. The saw has a malfunction.

## 11 Testing the Chain Saw and Battery

### 11.1 Checking the Chain Sprocket

- ▶ Switch off the chain saw, engage the chain brake and remove the battery.
- ▶ Disengage the chain brake.
- ▶ Remove the chain sprocket cover.
- ▶ Remove the bar and chain.

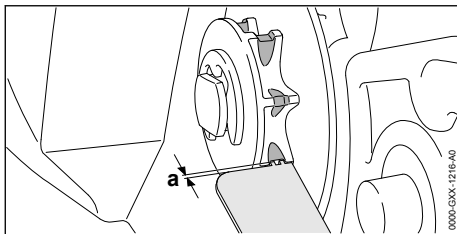

- ▶ Use a STIHL gauge to check the wear marks on the sprocket.
- ▶ If wear marks are deeper than  $a = 0.5$  mm: Do not use your chain saw and contact your STIHL servicing dealer. The chain sprocket must be replaced.

### 11.2 Checking the Guide Bar

- ▶ Switch off the chain saw, engage the chain brake and remove the battery.
- ▶ Remove the chain and guide bar.

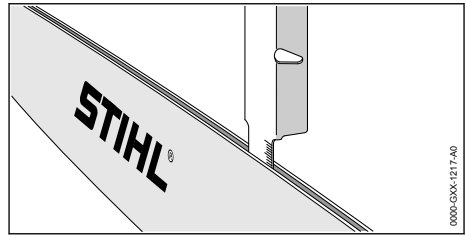

- ▶ Measure depth of bar groove with scale on STIHL filing gauge.
- ▶ Install a new guide bar if one of the following points applies:
  - Guide bar is damaged.
  - Measured bar depth is less than specified minimum depth,  20.3.
  - Bar groove is pinched or splayed.
- ▶ If you have any queries: Contact your STIHL servicing dealer.

### 11.3 Checking the Saw Chain

- ▶ Switch off the chainsaw, engage the chain brake and remove the battery.

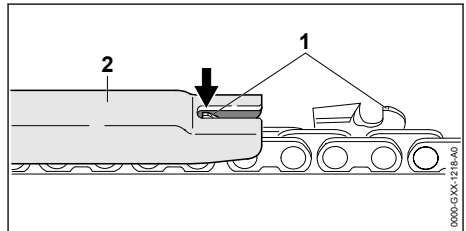

- ▶ Use a STIHL filing gauge (2) to check the height of the depth gauges (1). The STIHL filing gauge must match the chain pitch.
- ▶ If a depth gauge (1) projects from the filing gauge (2): Lower the depth gauge (1),  17.2.

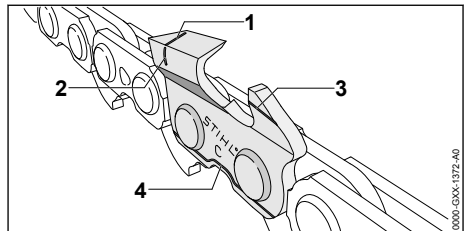

- ▶ Make sure the service marks (1 to 4) on the cutters are visible.
- ▶ If one of the service marks is not visible on a cutter: Do not use your chainsaw and contact your STIHL servicing dealer.

- ▶ Use a STIHL filing gauge to check that a filing angle of 30° has been maintained on all cutters. The STIHL filing gauge must match the chain pitch.
- ▶ If a filing angle of 30° has not been maintained: Resharpener the saw chain.
- ▶ If you have any queries: Contact your STIHL servicing dealer for assistance.

## 11.4 Testing the Chain Brake

- ▶ Engage the chain brake and remove the battery.

### WARNING

- The chain's cutters are very sharp. There is a risk of cut injuries.
    - ▶ Wear work gloves made of durable material.
- 
- ▶ Try to pull the chain along the guide bar by hand.
    - If the chain cannot be pulled along the bar by hand, the chain brake is functioning.
  - ▶ If the chain can be pulled along the bar by hand: Do not use your chain saw and contact your STIHL servicing dealer.
    - The chain brake is defective.

## 11.5 Checking the controls

### Lockout button, Ergo lever and trigger

- ▶ Engage chain brake and remove battery.
- ▶ Attempt to pull the trigger lever without depressing the lockout button.
- ▶ If the trigger can be pulled: Do not use your chainsaw and contact your STIHL servicing dealer.
  - The lockout button is defective.
- ▶ Press and hold the lockout button.
- ▶ Press and hold Ergo lever.
- ▶ Press the trigger.
  - Release the locking button.
- ▶ Release the trigger and the Ergo lever.
- ▶ If either the lockout button, Ergo lever or the trigger is stiff or does not spring back to the idle position: Do not use the chainsaw and contact your STIHL servicing dealer for assistance.
  - The lockout button, Ergo lever or trigger is defective.

### Switching on the chainsaw

- ▶ Insert battery.
- ▶ Disengage the chain brake.
- ▶ Press and hold the lockout button.
- ▶ Press and hold the trigger.
  - The saw chain starts running.

- ▶ If 3 LEDs flash red: Remove the battery and consult a STIHL dealer.
  - Malfunction in saw.
- ▶ Release the trigger.
  - The saw chain stops running.
- ▶ If the chain continues to rotate: Engage the chain brake, remove the battery and contact your STIHL servicing dealer.
  - Your saw has a malfunction.

## 11.6 Checking Chain Lubrication

- ▶ Fit the battery.
- ▶ Disengage the chain brake.
- ▶ Hold the guide bar over a light surface.
- ▶ Switch on the saw.
  - Chain oil is thrown off the chain and is visible on the light surface. Chain lubrication is operating properly.
- ▶ If no chain oil can be seen:
  - ▶ Fill up with chain oil.
  - ▶ Check chain lubrication again.
  - ▶ If chain oil is still not visible on the light surface: Do not use your chain saw and contact your STIHL servicing dealer. Chain lubrication is defective.

## 11.7 Testing the Battery

- ▶ Press button on battery.
  - The LEDs glow or flash.
- ▶ If the LEDs do not glow or flash: Do not use the battery and contact your STIHL servicing dealer.
  - There is a malfunction in the battery.

# 12 Operating the Saw

## 12.1 Holding and Controlling the Chainsaw

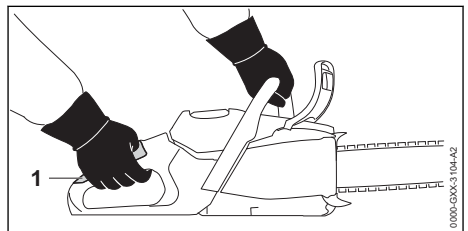

- ▶ Hold and control the chainsaw with your left hand on the handlebar and your right hand on the grip area (1) of the control handle so that your left thumb wraps around the handlebar and your right thumb wraps around the control handle.

## 12.2 Sawing

### ! WARNING

- If kickback occurs, the chainsaw can be thrown up in the direction of the operator. This may result in serious or fatal injury to the user.
    - ▶ Always cut with the chain running at full speed.
    - ▶ Do not cut with the upper quadrant of the guide bar nose.
- 
- ▶ Begin the cut with the chain running at full speed and keep the guide bar vertical.

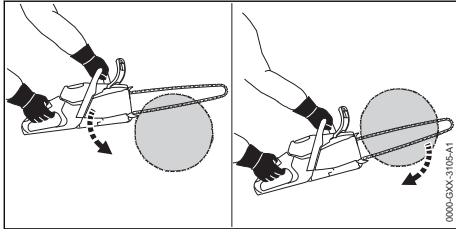

- ▶ Engage the spiked bumper and use it as a fulcrum.
- ▶ Guide the full width of the guide bar into the wood and reposition the spiked bumper as required.
- ▶ Pick up the weight of the chainsaw at the end of the cut.

For optimum performance, observe the recommended temperature ranges, 20.8.

## 12.3 Delimiting

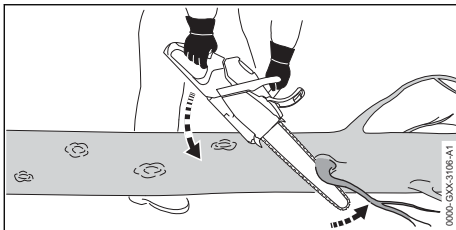

- ▶ Support the chainsaw on the log.
- ▶ With the chain running at full speed, pivot the guide bar downward against the limb.
- ▶ Cut through the limb with the top of the guide bar.

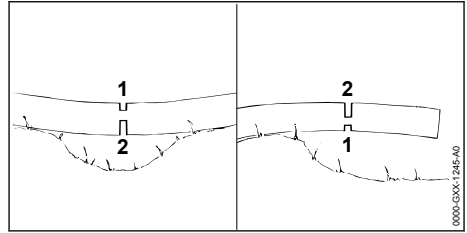

- ▶ If the limb is under tension: Make the relieving cut (1) into the compression side and then perform the bucking cut (2) from the tension side.

## 12.4 Felling

### 12.4.1 Determining direction of fall and escape path

- ▶ Determine direction of fall so that the area in which the tree falls is clear.

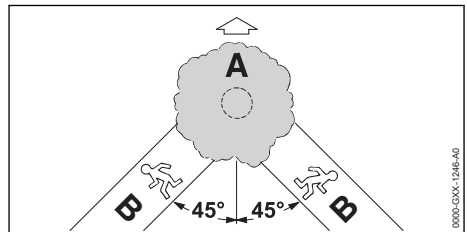

- ▶ Observe the following points when planning escape path (B):
  - Escape path (B) at an angle of 45° to direction of fall (A).
  - No obstacles on the escape path (B).
  - The top of the tree can be observed.
  - If the escape path (B) is on a slope, it must be parallel to the slope.

### 12.4.2 Preparing work area at base of tree

- ▶ Remove obstacles from work area at tree base.
- ▶ Remove growth from tree base.

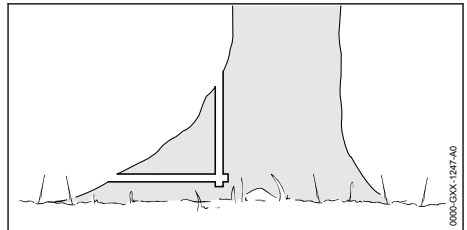

- ▶ If the tree has large, healthy buttress roots: Make vertical cut first and then a horizontal cut, and remove the resulting piece.

### 12.4.3 Cutting the felling notch

The felling notch determines the direction in which the tree falls. Country-specific standards for making the felling notch must be observed.

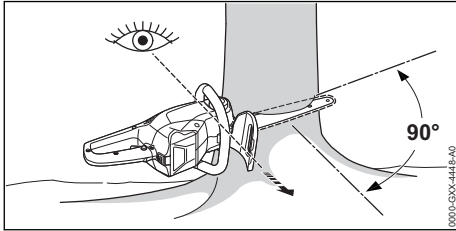

- ▶ Position the saw so that the felling notch is an right angles to the direction of fall and the saw is close to the ground.
- ▶ Make the horizontal cut.
- ▶ Make the angle cut at 45° to the horizontal cut.

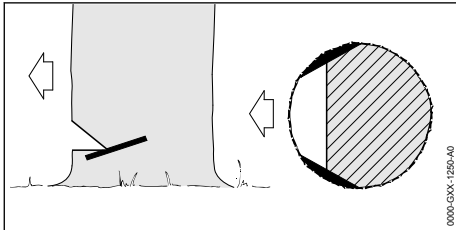

- ▶ If the wood is sound and long-fibered: Observe the following points when making sapwood cuts:
  - The cuts must be the same at both sides.
  - The cuts must be at the same height as the bottom of the felling notch.
  - The width of the cuts is 1/10 of the trunk diameter.
 The trunk does not splinter when the tree falls.

### 12.4.4 Basic information on felling cut

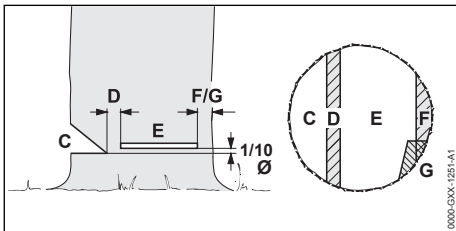

#### C Felling notch

The felling notch determines the direction of fall.

#### D Hinge

The hinge helps control the falling tree. The width of the hinge is 1/10 of the trunk diameter.

#### E Felling cut

The tree is felled with the felling cut. The felling cut is 1/10 of the trunk diameter (at least 3 cm) above the bottom of the felling notch.

#### F Stabilizing strap

The stabilizing strap supports the tree and helps prevent it from falling prematurely. The width of the stabilizing strap is 1/10 to 1/5 of the trunk diameter.

#### G Holding strap

The holding strap supports the tree and helps prevent it from falling prematurely. The width of the holding strap is 1/10 to 1/5 of the trunk diameter.

### 12.4.5 Plunge cutting

Plunge cutting is a technique required for felling.

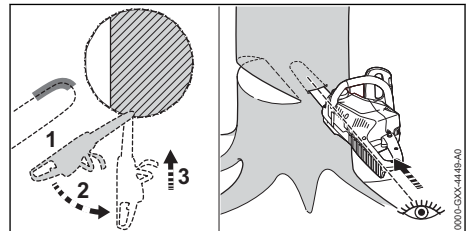

- ▶ Begin cut with the lower portion of the guide bar nose – with chain running at full speed.
- ▶ Cut until depth of kerf is twice the width of the guide bar.
- ▶ Swing the saw into plunge-cutting position.
- ▶ Perform the plunge cut.

### 12.4.6 Selecting the Appropriate Felling Cut

The choice of appropriate felling cut depends on the following conditions:

- The natural inclination of the tree
- The tree's branch formation
- Damage to the tree
- The tree's state of health
- If there is snow on the tree: the snow load
- The direction of slope
- Wind direction and speed
- Nearby trees, if any

There are different features of these conditions. Only two features are described in this Instruction Manual.

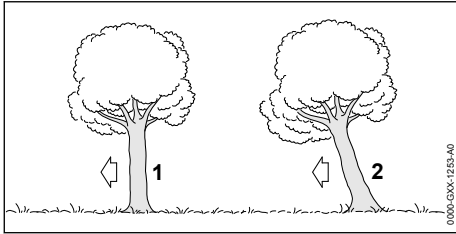

### 1 Normal tree

A normal tree is vertical and has an even crown.

### 2 Leaner

A leaner stands at an angle and the crown faces in the direction of fall.

### 12.4.7 Felling normal, small diameter tree

A normal tree is felled with a felling cut and stabilizing strap. This felling cut must be performed if the tree diameter is less than the guide bar's length.

- ▶ Shout a warning.

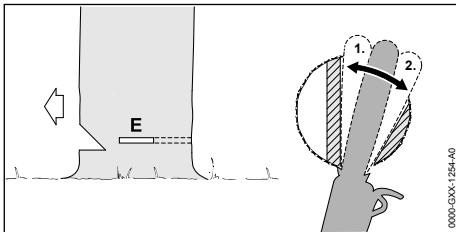

- ▶ Plunge the guide bar into the felling cut until it is visible at the other side of the trunk,  12.4.5.

- ▶ Apply the spiked bumper behind the hinge and use it as a pivot.
- ▶ Enlarge felling cut in direction of hinge.
- ▶ Enlarge felling cut in direction of stabilizing strap.

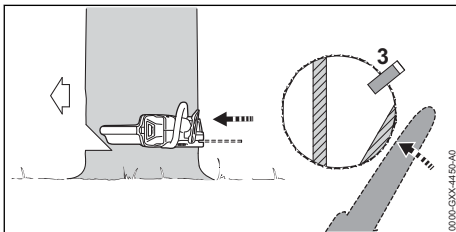

- ▶ Insert a felling wedge. The felling wedge must match the tree diameter and the width of the felling cut.
- ▶ Shout a warning.

- ▶ With outstretched arms, cut through the stabilizing strap horizontally from outside at the same level as the felling cut.  
The tree falls.

### 12.4.8 Felling normal, large diameter tree

A normal tree is felled with a felling cut and stabilizing strap. This felling cut must be performed if the tree diameter is greater than the guide bar's length.

- ▶ Shout a warning.

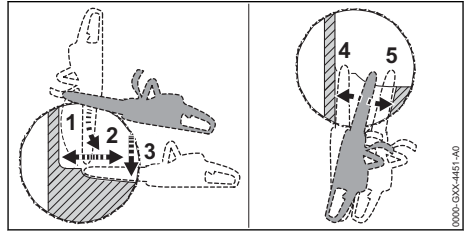

- ▶ Apply the spiked bumper at the same height as the felling cut and use it as a pivot.
- ▶ Hold the saw horizontally and swing it into the felling cut as far as possible.
- ▶ Enlarge felling cut in direction of hinge.
- ▶ Enlarge felling cut in direction of stabilizing strap.
- ▶ Move to the other side of the tree.
- ▶ Plunge the guide bar into the felling cut at the same height.
- ▶ Enlarge felling cut in direction of hinge.
- ▶ Enlarge felling cut in direction of stabilizing strap.

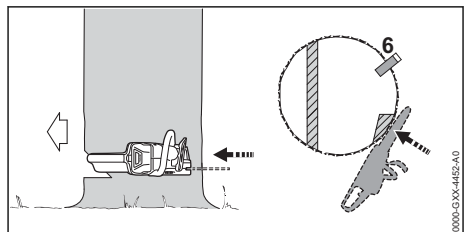

- ▶ Insert a felling wedge. The felling wedge must match the tree diameter and the width of the felling cut.
- ▶ Shout a warning.
- ▶ With outstretched arms, cut through the stabilizing strap horizontally from outside at the same level as the felling cut.  
The tree falls.



### 12.4.9 Felling a small diameter leaner

A leaner is felled with a felling cut and holding strap. This felling cut must be performed if the tree diameter is less than the guide bar's length.

- ▶ Shout a warning.

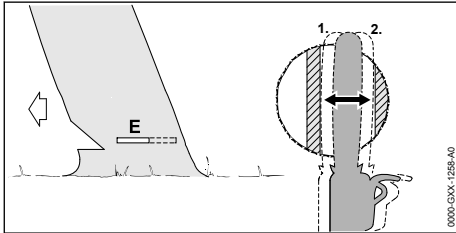

- ▶ Plunge the guide bar into the felling cut until it is visible at the other side of the trunk, 12.4.5.
- ▶ Enlarge felling cut in direction of hinge.
- ▶ Enlarge felling cut in direction of holding strap.

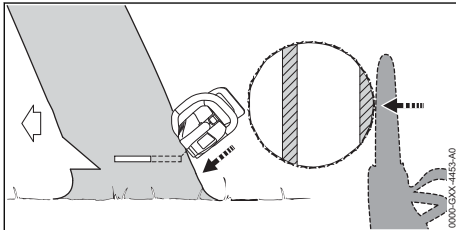

- ▶ Shout a warning.
- ▶ With arms outstretched, cut through the holding strap from outside at a downward angle. The tree falls.

### 12.4.10 Felling a large diameter leaner

A leaner is felled with a felling cut and holding strap. This felling cut must be performed if the tree diameter is greater than the guide bar's length.

- ▶ Shout a warning.

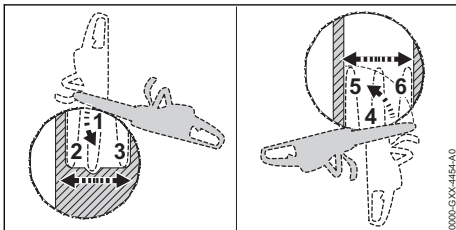

- ▶ Apply the spiked bumper behind the holding strap at the same height as the felling cut and use it as a pivot.
- ▶ Hold the saw horizontally and swing it into the felling cut as far as possible.

- ▶ Enlarge felling cut in direction of hinge.
- ▶ Enlarge felling cut in direction of holding strap.
- ▶ Move to the other side of the tree.
- ▶ Apply the spiked bumper behind the hinge at the same height as the felling cut and use it as a pivot.
- ▶ Hold the saw horizontally and swing it into the felling cut as far as possible.
- ▶ Enlarge felling cut in direction of hinge.
- ▶ Enlarge felling cut in direction of holding strap.

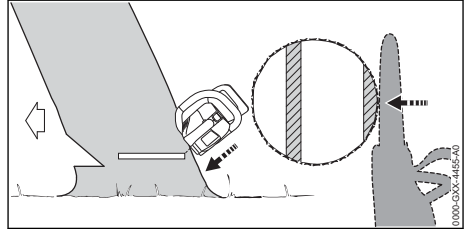

- ▶ Shout a warning.
- ▶ With arms outstretched, cut through the holding strap from outside at a downward angle. The tree falls.

## 13 After Finishing Work

### 13.1 After Finishing Work

- ▶ Switch off chainsaw, engage the chain brake and remove the battery.
- ▶ If the chainsaw is wet: Allow the chainsaw to dry.
- ▶ If the battery is moist or wet: Allow the battery to dry, 20.8.
- ▶ Clean the chainsaw.
- ▶ Clean the guide bar and saw chain.
- ▶ Loosen the wingnut.
- ▶ Turn the adjusting wheel 2 turns counterclockwise. The saw chain is now slack.
- ▶ Tighten the wing nut.
- ▶ Push the chain scabbard over the guide bar so that it completely covers the guide bar.
- ▶ Clean the battery.

## 14 Transporting

### 14.1 Transporting the Chainsaw

- ▶ switch off chain saw, engage chain brake and remove battery
- ▶ Fit the chain scabbard so that it completely covers the guide bar.

### Carrying the chainsaw

- ▶ Carry the chainsaw by holding the front handle in your right hand with the guide bar pointing to the rear.

### Carrying the chainsaw in a vehicle

- ▶ Secure the saw to prevent turnover and movement.

## 14.2 Transporting the Battery

- ▶ Switch off the chainsaw, engage the chain brake and remove the battery.
- ▶ Check that the battery is in a safe condition.
- ▶ Pack the battery in packaging in such a way that it cannot move inside the packaging.
- ▶ Secure the packaging so that it cannot move.

The battery is subject to the Carriage of Dangerous Goods regulations. The battery is classified as UN 3480 (lithium ion batteries) and has been tested pursuant to UN Manual Tests and Criteria Part III, Subsection 38.3.

The transport regulations can be found at [www.stihl.com/safety-data-sheets](http://www.stihl.com/safety-data-sheets).

## 14.3 Transporting the Charger

- ▶ Disconnect the plug from the wall outlet.
- ▶ Remove the battery.
- ▶ Wind up the connecting cable and attach it to the charger.
- ▶ Transporting the charger in a vehicle: Secure the charger with lashing straps, belts or a net to prevent it turning over and moving.

# 15 Storing

## 15.1 Storing the Chainsaw

- ▶ Switch off the chainsaw, engage the chain brake and remove the battery.
- ▶ Fit the scabbard so that it completely covers the guide bar.
- ▶ Observe the following points when storing the saw:
  - Saw is out of the reach of children.
  - The saw is clean and dry.
- ▶ If you store the saw for more than 30 days: Remove the bar and chain.

## 15.2 Storing the Battery

STIHL recommends keeping the battery in a charging state between 40% and 60 % (2 green LEDs lit).

- ▶ The battery should be stored in such a way that the following conditions are fulfilled:
  - The battery is out of the reach of children.
  - The battery is clean and dry.

- The battery is in an enclosed space.
- Keep the battery separate from the chainsaw.
- If the battery is stored in the charger, disconnect the mains plug and store the battery at a state of charge between 40% and 60% (2 lit green LEDs).
- Do not store the battery outside of the specified temperature limits,  20.7.

### NOTICE

- If the battery is not stored as described in this User Manual, the battery may become deeply discharged and irreparably damaged.
  - ▶ Charge a discharged battery before storing it. STIHL recommends keeping the battery state of charge between 40% and 60% (2 lit green LEDs).
  - ▶ Store the battery separately from the chainsaw.

## 15.3 Storing the Charger

- ▶ Disconnect the mains plug from the power supply.

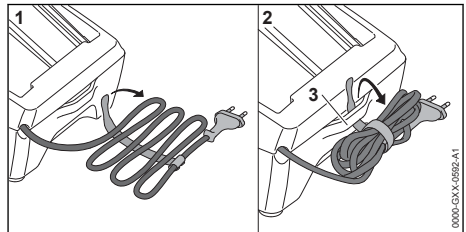

- ▶ Wind up the connecting cable and attach it to the charger.
- ▶ Observe the following points when storing the charger:
  - Charger is out of the reach of children.
  - The charger is clean and dry.
  - Charger is in an enclosed space.
  - The charger is not suspended from the connecting cable or the holder (3) for the connecting cable.
  - Do not store the charger outside of the specified temperature limits,  20.7.

# 16 Cleaning

## 16.1 Cleaning the chainsaw

- ▶ switch off chain saw, engage chain brake and remove battery
- ▶ Clean the chainsaw with a damp cloth or STIHL resin solvent.
- ▶ Clean vents with a paintbrush.
- ▶ Remove the chain sprocket cover.

- ▶ Clean the area around the chain sprocket with a damp cloth or STIHL resin solvent.
- ▶ Remove foreign objects from the battery compartment and clean the battery compartment with a damp cloth.
- ▶ Clean the electrical contacts in the battery compartment with a paintbrush or soft brush.
- ▶ Fit the chain sprocket cover.

## 16.2 Cleaning the Bar and Chain

- ▶ Switch off the chain saw, engage the chain brake and remove the battery.
- ▶ Remove the bar and chain.

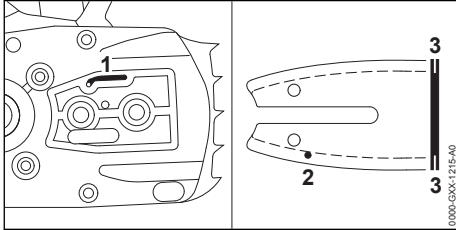

- ▶ Clean the oil port (1), oil inlet hole (2) and bar groove (3) with a soft brush or STIHL resin solvent.
- ▶ Clean the saw chain with a soft brush or STIHL resin solvent.
- ▶ Mount the bar and chain.

## 16.3 Cleaning the Battery

- ▶ Clean the battery with a damp cloth.

## 16.4 Cleaning the Charger

- ▶ Disconnect the mains plug from the power supply.
- ▶ Clean the charger with a damp cloth.
- ▶ Clean vents with a paintbrush.
- ▶ Clean the charger's electrical contacts with a paintbrush or a soft brush.

# 17 Maintenance

## 17.1 Deburring the Guide Bar

A burr can build up on the outer edge of the guide bar.

- ▶ Remove burr with a flat file or a STIHL guide bar dressing tool.
- ▶ If you have any queries: Contact your STIHL servicing dealer.

## 17.2 Sharpening the Saw Chain

Correctly sharpening saw chains requires a lot of practice.

STIHL files, STIHL filing aids, STIHL sharpeners and the brochure "Sharpening STIHL Saw Chains" help you achieve the right results. To obtain the brochure visit <http://www.stihl.com/sharpening-brochure>.

STIHL recommends you have saw chains resharpened by a STIHL servicing dealer.

### ! WARNING

- The chain's cutters are very sharp. There is a risk of cut injuries.
  - ▶ Wear work gloves made of durable material.

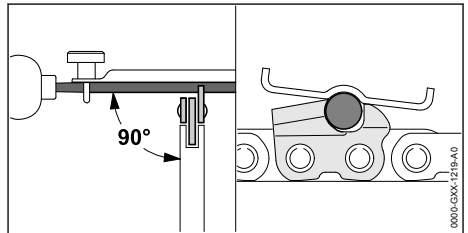

- ▶ File each cutter with a round file so that the following points are observed:
  - Round file matches the chain pitch.
  - File from the inside to the outside of the cutter.
  - Hold the file at right angle to the guide bar.
  - Maintain a filing angle of 30°.

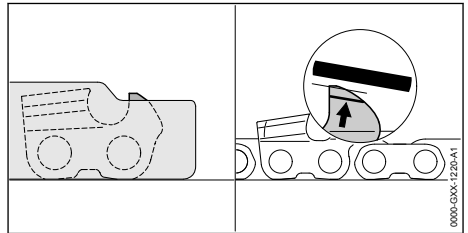

- ▶ File down the depth gauges with a flat file so that they are level with the STIHL filing gauge and parallel to the service mark. The STIHL filing gauge must match the chain pitch.
- ▶ If you have any queries: Contact your STIHL servicing dealer for assistance.

## 17.3 Chain Brake Maintenance

The chain brake cannot be serviced by the user.

- ▶ Have the chain brake serviced by a STIHL dealer at the following intervals:
  - Full-time use: every three months
  - Part-time use: every six months
  - Occasional use: once a year

## 18 Repairing

### 18.1 Repairing Chain Saw, Battery and Charger

The saw, guide bar, saw chain, battery and charger are not user serviceable.

- ▶ If the saw, guide bar or saw chain is damaged: Do not use your saw, guide bar or saw chain, and contact your STIHL servicing dealer.

- ▶ If the battery has a malfunction or is damaged: Replace the battery.
- ▶ If the charger has a malfunction or is damaged: Replace the charger.
- ▶ If the connecting cable has a malfunction or is damaged: Do not use the charger and have connecting cable replaced by a STIHL servicing dealer.

## 19 Troubleshooting

### 19.1 Troubleshooting Chainsaw or Battery

Fault	LEDs on the battery	Cause	Remedy
Saw does not start when switched on.	1 LED flashing green.	State of charge of the battery is too low.	▶ Charge the battery.
	1 LED emits red light.	The battery is too warm or too cold.	▶ Engage chain brake and remove battery. ▶ Allow the battery to cool down or warm up.
	3 LEDs flash red.	Chainsaw fault.	▶ Engage chain brake and remove battery. ▶ Clean electrical contacts in the battery compartment. ▶ Insert battery. ▶ Disengage the chain brake. ▶ Switch on the chainsaw. ▶ If 3 LEDs continue to flash red: Do not use your chainsaw and contact your STIHL servicing dealer for assistance.
	3 LEDs light up red.	Chainsaw is too hot.	▶ Engage chain brake and remove battery. ▶ Allow the chainsaw to cool down for 20 minutes.
	4 LEDs flash red.	There is a fault in the battery.	▶ Engage the chain brake, remove and refit the battery. ▶ Disengage the chain brake. ▶ Switch on the chainsaw. ▶ If 4 LEDs continue to flash red: Do not use the battery; contact a STIHL authorized dealer.
	-	No electrical contact between the chainsaw and battery.	▶ Engage chain brake and remove battery. ▶ Clean electrical contacts in the battery compartment. ▶ Insert battery.
	-	Chainsaw or battery damp.	▶ Allow chainsaw or battery to dry, ☞ 20.8.
Saw cuts out during operation.	3 LEDs light up red.	Chainsaw is too hot.	▶ Engage chain brake and remove battery. ▶ Allow the chainsaw to cool down for 20 minutes.
	-	There is an electrical fault.	▶ Engage the chain brake, remove and refit the battery. ▶ Switch on the chainsaw.
Chainsaw run-time is too short.	-	The battery is not fully charged.	▶ Fully charge the battery.
	-	The battery life has been exceeded.	▶ Replace battery.

Fault	LEDs on the battery	Cause	Remedy
Charging does not start when the battery is inserted into the charger.	1 LED emits red light.	The battery is too warm or too cold.	▶ Leave battery inserted in charger. Charging starts automatically as soon as the permitted temperature range is reached.

## 19.2 Troubleshooting the Charger

Fault	LED on Charger	Cause	Remedy
Battery not being charged.	The LED flashes red.	No electrical contact between charger and battery.	▶ Remove the battery. ▶ Clean contacts on charger. ▶ Insert battery.
		There is a malfunction in the charger.	▶ Do not use the charger and contact your STIHL dealer for assistance.

## 20 Specifications

### 20.1 STIHL MSA 60.0 C, MSA 70.0 C Chainsaws

#### MSA 60.0 C

- Approved battery: STIHL AK
- Weight without battery, guide bar and saw chain: 2.5 kg
- Max. oil tank capacity: 110 cm<sup>3</sup> (0.11 l)

#### MSA 70.0 C

- Approved battery: STIHL AK
- Weight without battery, guide bar and saw chain: 2.5 kg
- Max. oil tank capacity: 110 cc (0.11 l)

For runtime, see [www.stihl.com/battery-life](http://www.stihl.com/battery-life).

### 20.2 Chain Sprockets and Chain Speeds

#### MSA 60.0 C

- The following chain sprockets may be used:
- 6-tooth for 1/4" P
  - Maximum chain speed: 14.0 m/s

#### MSA 70.0 C

- The following chain sprockets may be used:
- 6-tooth for 1/4" P
  - Maximum chain speed: 14.0 m/s

### 20.3 Minimum groove depth of guide bars

The minimum groove depth depends on the pitch of the guide bar.

- 1/4" P 4 mm

### 20.4 STIHL AK Battery

- Battery technology: lithium-ion

- Voltage: 36 V
- Capacity in Ah: see rating label
- Energy content in Wh: see rating label
- Weight in kg: See rating label

### 20.5 STIHL AL 101 Charger

- Rated voltage: See rating plate
- Frequency: see rating plate
- Rated power: see rating plate
- Charging current: See rating plate

For charging times, see [www.stihl.com/charging-times](http://www.stihl.com/charging-times).

### 20.6 Extension Cords

If an extension cord is used, the cross sectional area of its conductors must meet the following minimum requirements – depending on the line voltage and length of the extension cord:

#### If rated voltage on the rating label is 220V to 240V:

- Cord length up to 20 m: AWG 15 / 1.5 mm<sup>2</sup>
- Cord length 20 m up to 50 m: AWG 13 / 2.5 mm<sup>2</sup>

#### If rated voltage on the rating label is 100V to 127V:

- Cord length up to 10 m: AWG 14 / 2.0 mm<sup>2</sup>
- Cord length 10 m up to 30 m: AWG 12 / 3.5 mm<sup>2</sup>

## 20.7 Temperature limits



### WARNING

- The battery is not protected against all ambient conditions. If the battery is exposed to certain ambient conditions, it may catch fire or explode. This may result in serious injury to people and damage to property.
  - ▶ Do not charge the battery below  $-20^{\circ}\text{C}$  or above  $+50^{\circ}\text{C}$ .
  - ▶ Do not use the chainsaw, battery or charger below  $-20^{\circ}\text{C}$  or above  $+50^{\circ}\text{C}$ .
  - ▶ Do not store the chainsaw, battery or charger below  $-20^{\circ}\text{C}$  or above  $+70^{\circ}\text{C}$ .

## 20.8 Recommended temperature ranges

For optimum performance of the chainsaw, battery and charger, observe the following temperature ranges:

- Charging:  $5^{\circ}\text{C}$  to  $40^{\circ}\text{C}$
- Use:  $-10^{\circ}\text{C}$  to  $+40^{\circ}\text{C}$
- Storage:  $-20^{\circ}\text{C}$  to  $+50^{\circ}\text{C}$

If the battery is charged, used or stored outside the recommended temperature ranges, performance may be reduced.

If the battery is wet or moist, allow the battery to dry for at least 48 h between  $15^{\circ}\text{C}$  and  $50^{\circ}\text{C}$  and with less than 70% humidity. Higher humidity may extend the drying time.

## 20.9 Sound Values and Vibration Values

The K-value for the sound pressure level is 2 dB(A). The K-value for the sound power level is 2 dB(A). K-value for vibration level is  $2\text{ m/s}^2$ .

### MSA 60.0 C

STIHL recommends wearing ear defenders.

- Sound pressure level  $L_{pA}$  measured according to EN 62841-4-1: 83 dB(A)

- Sound power level  $L_{wA}$  measured according to EN 62841-4-1: 94 dB(A)
- Vibration level  $a_{hv}$  measured according to EN 62841-4-1:
  - Control handle:  $3.4\text{ m/s}^2$
  - Front handle:  $3.2\text{ m/s}^2$ .

### MSA 70.0 C

STIHL recommends wearing ear defenders.

- Sound pressure level  $L_{pA}$  measured according to EN 62841-4-1: 83 dB(A)
- Sound power level  $L_{wA}$  measured according to EN 62841-4-1: 94 dB(A)
- Vibration level  $a_{hv}$  measured according to EN 62841-4-1:
  - Control handle:  $3.4\text{ m/s}^2$
  - Handlebar:  $3.2\text{ m/s}^2$ .

The sound and vibration levels indicated were measured according to a standardized test method and can be used as a basis for comparing electric power tools. The actual sound and vibration levels may vary from the values indicated, depending on the type of application. The sound and vibration levels indicated can be used for an initial estimate of the sound and vibration stress. The actual sound and vibration stress has to be estimated. The times can be taken into account in the estimate when the electric power tool is switched off and also when it is switched on but running without any load.

For information on compliance with Employers' Vibration Directive 2002/44/EC see [www.stihl.com/vib](http://www.stihl.com/vib).

## 20.10 REACH

REACH is an EC regulation and stands for the Registration, Evaluation, Authorisation and Restriction of Chemical substances.

For information on compliance with the REACH regulation see [www.stihl.com/reach](http://www.stihl.com/reach).

# 21 Bar and Chain Combinations

## 21.1 STIHL MSA 60.0 C, MSA 70.0 C Chainsaws

Pitch	Drive link gauge/groove width	Length	Guide bar	Number of teeth, sprocket nose	Number of drive links	Saw chain
1/4" P	1.1 mm	25 cm	Rolo-matic E Mini / Light 01	8	56	71 PM3 (type 3670)
		30 cm			64	
		30 cm	Carving		-	

Pitch	Drive link gauge/groove width	Length	Guide bar	Number of teeth, sprocket nose	Number of drive links	Saw chain
The cutting length of a guide bar depends on the chainsaw and the saw chain being used. The actual cutting length of a guide bar may be less than the specified length.						

## 22 Spare Parts and Accessories

### 22.1 Spare parts and accessories

**STIHL** These symbols indicate original STIHL spare parts and original STIHL accessories.

STIHL recommends the use of original STIHL spare parts and accessories.

Despite ongoing market observation, STIHL is unable to judge the reliability, safety and suitability of other manufacturers' spare parts and accessories; accordingly, STIHL cannot warrant for the use of those parts.

Original STIHL spare parts and original STIHL accessories are available from STIHL dealers.

## 23 Disposal

### 23.1 Disposal of Chain Saw, Battery and Charger

Contact the local authorities or your STIHL dealer for information on disposal.

Improper disposal can be harmful to health and pollute the environment.

- ▶ Take STIHL products including packaging to a suitable collection point for recycling in accordance with local regulations.
- ▶ Do not dispose with domestic waste.

## 24 EC Declaration of Conformity

### 24.1 STIHL MSA 60.0 C, MSA 70.0 C Chainsaws

ANDREAS STIHL AG & Co. KG  
Badstraße 115  
D-71336 Waiblingen

Germany

declare under our sole responsibility that

- Category: Cordless chainsaw
- Manufacturer's brand: STIHL
- Model: MSA 60.0, serial number: MA04
- Model: MSA 70.0, serial number: MA04

conforms to the relevant provisions of Directives 2011/65/EU, 2006/42/EC, 2014/30/EU and 2000/14/EC and has been developed and manufactured in compliance with the following standards in the versions valid on the date of production: EN 55014-1, EN 55014-2, EN 62841-1 and EN 62841-4-1.

The EC type examination test was carried out pursuant to Directive 2006/42/EC, Art. 12.3(b) at: VDE Prüf- u. Zertifizierungsinstitut (NB 0366), Merianstraße 28, 63069 Offenbach, Germany – Certification number: 40055452

The measured and guaranteed equivalent sound power level has been determined in accordance with Directive 2000/14/EC, Annex V.

MSA 60.0 C

- Measured sound power level: 95 dB(A)
- Guaranteed sound power level: 97 dB(A)

MSA 70.0 C

- Measured sound power level: 96 dB(A)
- Guaranteed sound power level: 98 dB(A)

The technical documents are stored at ANDREAS STIHL AG & Co. KG Produktzulassung.

The year of manufacture, country of manufacture and serial number are indicated on the chainsaw.

Waiblingen, 2022-09-30

ANDREAS STIHL AG & Co. KG

pp 

Robert Olma, Vice President, Regulatory Affairs & Global Governmental Relations

## 25 UKCA Declaration of Conformity

### 25.1 STIHL MSA 60.0 C, MSA 70.0 C Chainsaws

**UK  
CA**

ANDREAS STIHL AG & Co. KG



Badstraße 115  
D-71336 Waiblingen  
Germany

declare under our sole responsibility that

- Category: Cordless chainsaw
- Manufacturer's brand: STIHL
- Model: MSA 60.0, serial number: MA04
- Model: MSA 70.0, serial number: MA04

conforms to the relevant provisions of UK regulations The Restriction of the Use of Certain Hazardous Substances in Electrical and Electronic Equipment Regulations 2012, Supply of Machinery (Safety) Regulations 2008, Electromagnetic Compatibility Regulations 2016 and Noise Emission in the Environment by Equipment for use Outdoors Regulations 2001 and has been manufactured in compliance with the following standards in the versions valid on the date of production: EN 55014-1, EN 55014-2, EN 62841-1, and EN 62841-4-1.

The type examination test was carried out at: VDE Prüf- u. Zertifizierungsinstitut (NB 0366), Merianstraße 28, 63069 Offenbach, Germany  
– Certification number: 40055452

The measured and guaranteed sound power levels were determined in accordance with the UK regulation Noise Emission in the Environment by Equipment for use Outdoors Regulations 2001, Schedule 8.

MSA 60.0 C

- Measured sound power level: 95 dB(A)
- Guaranteed sound power level: 97 dB(A)

MSA 70.0 C

- Measured sound power level: 96 dB(A)
- Guaranteed sound power level: 98 dB(A)

The technical documents are stored at ANDREAS STIHL AG & Co. KG.

The year of manufacture, country of manufacture and serial number are indicated on the chainsaw.

Waiblingen, 2022-09-30

ANDREAS STIHL AG & Co. KG

pp 

Robert Olma, Vice President, Regulatory Affairs & Global Governmental Relations

## 26 General Power Tool Safety Warnings

### 26.1 Introduction

This chapter reproduces the pre-formulated, general safety precautions specified in the IEC 62841 standard for hand-held motor-operated electric tools.

STIHL is obliged to publish these texts.

The safety precautions and warnings on avoiding an electric shock given under "Electrical Safety" do not apply to STIHL cordless products.



#### WARNING

- **Read all safety warnings, instructions, illustrations and specifications provided with this power tool.** Failure to follow all instructions listed below may result in electric shock, fire and/or serious injury. **Save all warnings and instructions for future reference.**

The term "electric power tool" in the safety warnings refers to mains-operated (corded) power tools or battery-operated (cordless) power tools.

### 26.2 Work area safety

- a) **Keep work area clean and well lit.** Cluttered or dark areas invite accidents.
- b) **Do not operate power tools in explosive atmospheres, such as in the presence of flammable liquids, gases or dust.** Power tools create sparks which may ignite the dust or fumes.
- c) **Keep children and bystanders away while operating a power tool.** Distractions can cause you to lose control.

### 26.3 Electrical safety

- a) **Power tool plugs must match the outlet. Never modify the plug in any way. Do not use any adapter plugs with earthed (grounded) power tools.** Unmodified plugs and matching outlets will reduce risk of electric shock.
- b) **Avoid body contact with earthed or grounded surfaces, such as pipes, radiators, ranges and refrigerators.** There is an increased risk of electric shock if your body is earthed or grounded.
- c) **Do not expose power tools to rain or wet conditions.** Water entering a power tool will increase the risk of electric shock.

- d) **Do not abuse the cord. Never use the cord for carrying, pulling or unplugging the power tool. Keep cord away from heat, oil, sharp edges or moving parts.** Damaged or entangled cords increase the risk of electric shock.
- e) **When operating a power tool outdoors, use an extension cord suitable for outdoor use.** Use of a cord suitable for outdoor use reduces the risk of electric shock.
- f) **If operating a power tool in a damp location is unavoidable, use a residual current device (RCD) protected supply.** Use of an RCD reduces the risk of electric shock.

## 26.4 Personal safety

- a) **Stay alert, watch what you are doing and use common sense when operating a power tool. Do not use a power tool while you are tired or under the influence of drugs, alcohol or medication.** A moment of inattention while operating power tools may result in serious personal injury.
- b) **Use personal protective equipment. Always wear eye protection.** Protective equipment such as a dust mask, non-skid safety shoes, hard hat or hearing protection used for appropriate conditions will reduce personal injuries.
- c) **Prevent unintentional starting. Ensure the switch is in the off-position before connecting to power source and/or battery pack, picking up or carrying the tool.** Carrying power tools with your finger on the switch or energising power tools that have the switch on invites accidents.
- d) **Remove any adjusting key or wrench before turning the power tool on.** A wrench or a key left attached to a rotating part of the power tool may result in personal injury.
- e) **Do not overreach. Keep proper footing and balance at all times.** This enables better control of the power tool in unexpected situations.
- f) **Dress properly. Do not wear loose clothing or jewellery. Keep your hair and clothing away from moving parts.** Loose clothes, jewellery or long hair can be caught in moving parts.
- g) **If devices are provided for the connection of dust extraction and collection facilities, ensure these are connected and properly used.** Use of dust collection can reduce dust-related hazards.
- h) **Do not let familiarity gained from frequent use of tools allow you to become complacent and ignore tool safety principles.** A careless action can cause severe injury within a fraction of a second.

## 26.5 Power tool use and care

- a) **Do not force the power tool. Use the correct power tool for your application.** The correct power tool will do the job better and safer at the rate for which it was designed.
- b) **Do not use the power tool if the switch does not turn it on and off.** Any power tool that cannot be controlled with the switch is dangerous and must be repaired.
- c) **Disconnect the plug from the power source and/or remove the battery pack, if detachable, from the power tool before making any adjustments, changing accessories, or storing power tools.** Such preventive safety measures reduce the risk of starting the power tool accidentally.
- d) **Store idle power tools out of the reach of children and do not allow persons unfamiliar with the power tool or these instructions to operate the power tool.** Power tools are dangerous in the hands of untrained users.
- e) **Maintain power tools and accessories. Check for misalignment or binding of moving parts, breakage of parts and any other condition that may affect the power tool's operation. If damaged, have the power tool repaired before use.** Many accidents are caused by poorly maintained power tools.
- f) **Keep cutting tools sharp and clean.** Properly maintained cutting tools with sharp cutting edges are less likely to bind and are easier to control.
- g) **Use the power tool, accessories and tool bits etc. in accordance with these instructions, taking into account the working conditions and the work to be performed.** Use of the power tool for operations different from those intended could result in a hazardous situation.
- h) **Keep handles and grasping surfaces dry, clean and free from oil and grease.** Slippery handles and grasping surfaces do not allow for safe handling and control of the tool in unexpected situations.

## 26.6 Battery tool use and care

- a) **Recharge only with the charger specified by the manufacturer.** A charger that is suitable for one type of battery pack may create a risk of fire when used with another battery pack.
- b) **Use power tools only with specifically designated battery packs.** Use of any other battery packs may create a risk of injury and fire.
- c) **When battery pack is not in use, keep it away from other metal objects, like paper clips, coins, keys, nails, screws or other small metal objects, that can make a connection from one terminal to another.** Shorting the battery terminals together may cause burns or a fire.
- d) **Under abusive conditions, liquid may be ejected from the battery; avoid contact. If contact accidentally occurs, flush with water. If liquid contacts eyes, additionally seek medical help.** Liquid ejected from the battery may cause irritation or burns.
- e) **Do not use a battery pack or tool that is damaged or modified.** Damaged or modified batteries may exhibit unpredictable behaviour resulting in fire, explosion or risk of injury.
- f) **Do not expose a battery pack or tool to fire or excessive temperature.** Exposure to fire or temperature above 130 °C may cause explosion.
- g) **Follow all charging instructions and do not charge the battery pack or tool outside the temperature range specified in the instructions.** Charging improperly or at temperatures outside the specified range may damage the battery and increase the risk of fire.

## 26.7 Service

- a) **Have your power tool serviced by a qualified repair person using only identical replacement parts.** This will ensure that the safety of the power tool is maintained.
- b) **Never service damaged battery packs.** Service of battery packs should only be performed by the manufacturer or authorized service providers.

## 26.8 Chain Saw Safety Warnings

### General safety warnings for chain saws

- a) **Keep all parts of your body away from the saw chain when the chain saw is operating. Before you start the chain saw, make sure the saw chain does not touch anything. A**

moment of inattention while operating chain saws may cause entanglement of your clothing or body with the saw chain.

- b) **Always hold the chain saw with your right hand on the rear handle and your left hand on the front handle.** Holding the chain saw with a reversed hand configuration increases the risk of personal injury and should never be done.
- c) **Hold the chain saw by insulated gripping surfaces only, because the saw chain may contact hidden wiring or its own cord.** Saw chains contacting a "live" wire may make exposed metal parts of the chain saw "live" and could give the operator an electric shock.
- d) **Wear eye protection. Further protective equipment for hearing, head, hands, legs and feet is recommended.** Adequate protective equipment will reduce personal injury from flying debris or accidental contact with the saw chain.
- e) **Do not operate a chain saw in a tree, on a ladder, from a rooftop, or any unstable support.** Operation of a chain saw in this manner could result in serious personal injury.
- f) **Always keep proper footing and operate the chain saw only when standing on a fixed, secure and level surface.** Slippery or unstable surfaces may cause a loss of balance or control of the chain saw.
- g) **When cutting a limb that is under tension be alert for spring back.** When the tension in the wood fibers is released the spring loaded limb may strike the operator and/or throw the chain saw out of control.
- h) **Use extreme caution when cutting brush and saplings.** The slender material may catch the saw chain and be whipped toward you or pull you off balance.
- i) **Carry the chain saw by the front handle with the chain saw switched off and away from your body. When transporting or storing the chain saw, always fit the guide bar cover.** Proper handling of the chain saw will reduce the likelihood of accidental contact with the moving saw chain.
- j) **Follow the instructions for lubricating, chain tensioning and changing the bar and chain.** Improperly tensioned or lubricated chain may either break or increase the chance for kick-back.

- k) **Cut wood only. Do not use chain saw for purposes not intended. For example: do not use chain saw for cutting metal, plastic, masonry or non-wood building materials.** Use of the chain saw for operations different than intended could result in a hazardous situation.
  - l) **Do not attempt to fell a tree until you have an understanding of the risks and how to avoid them.** Serious injury could occur to the operator or bystanders while felling a tree.
  - m) **Follow all the instructions for removing accumulated material from the chainsaw and for storing or servicing the chainsaw. Make sure that the switch is set to "Off" and the battery block has been removed.** Unexpected startup of the chainsaw during removal of accumulated material or during maintenance work may cause severe injuries.
- **Only use replacement guide bars and saw chains specified by the manufacturer.** Incorrect replacement guide bars and saw chains may cause chain breakage and/or kickback.
  - **Follow the manufacturer's sharpening and maintenance instructions for the saw chain.** Decreasing the depth gauge height can lead to increased kickback.

## 26.9 Causes and operator prevention of kickback

Kickback may occur when the nose or tip of the guide bar touches an object, or when the wood closes in and pinches the saw chain in the cut.

Tip contact in some cases may cause a sudden reverse reaction, kicking the guide bar up and back towards the operator.

Pinching the saw chain along the top of the guide bar may push the guide bar rapidly back towards the operator.

Either of these reactions may cause you to lose control of the saw which could result in serious personal injury. Do not rely exclusively upon the safety devices built into your saw. As a chain saw user, you should take several steps to keep your cutting jobs free from accident or injury.

Kickback is the result of chain saw misuse and/or incorrect operating procedures or conditions and can be avoided by taking proper precautions as given below:

- **Maintain a firm grip, with thumbs and fingers encircling the chain saw handles, with both hands on the saw and position your body and arm to allow you to resist kickback forces.** Kickback forces can be controlled by the operator, if proper precautions are taken. Do not let go of the chain saw.
- **Do not overreach and do not cut above shoulder height.** This helps prevent unintended tip contact and enables better control of the chain saw in unexpected situations.





[www.stihl.com](http://www.stihl.com)



0458-022-8301-A



0458-022-8301-A